

# CATÁLOGO GENERAL

ABRIL - MAYO 2026

*jungla*



*jungla*



KETTLE JOE'S  
PARRILLA A CARBÓN PORTATIL



**SMOKE 14"**  
1126701



**SMOKEY  
JOE 14"**  
Q800

DISPONIBLE EN TIENDA ZONA 10\*\*



7154

**CARRY  
COVER**

PARA SMOKEY JOE 14"

Q350



**CARBÓN**

  
CARBÓN

14.5"



Interior

 | Char Go Anywhere

**Q1,400**

1500763



*jungla*



WEBER KETTLE  
PARRILLA A CARBÓN



KETTLE PREMIUM 22"

**Q3,300**  
14401001



KETTLE PREMIUM 18"

**Q2,000**  
441001



JUMBO JOE 18"

**Q1,400**  
1211001



**CARBÓN**



**GRILL COVER**  
COMPATIBLE CON CHURRASQUERAS DE CARBÓN 22"

**Q225**  
7176

**PREMIUM GRILL COVER**  
COMPATIBLE CON CHURRASQUERAS DE CARBÓN 22"

**Q500**  
7150

**PREMIUM GRILL COVER**  
COMPATIBLE CON CHURRASQUERAS DE CARBÓN 26"

**SOLD OUT**  
7153

*jungla*



MASTER TOUCH  
PARRILLA A CARBÓN





# MASTER TOUCH

GBS 22''

## Q4,200

14501001



CARBÓN

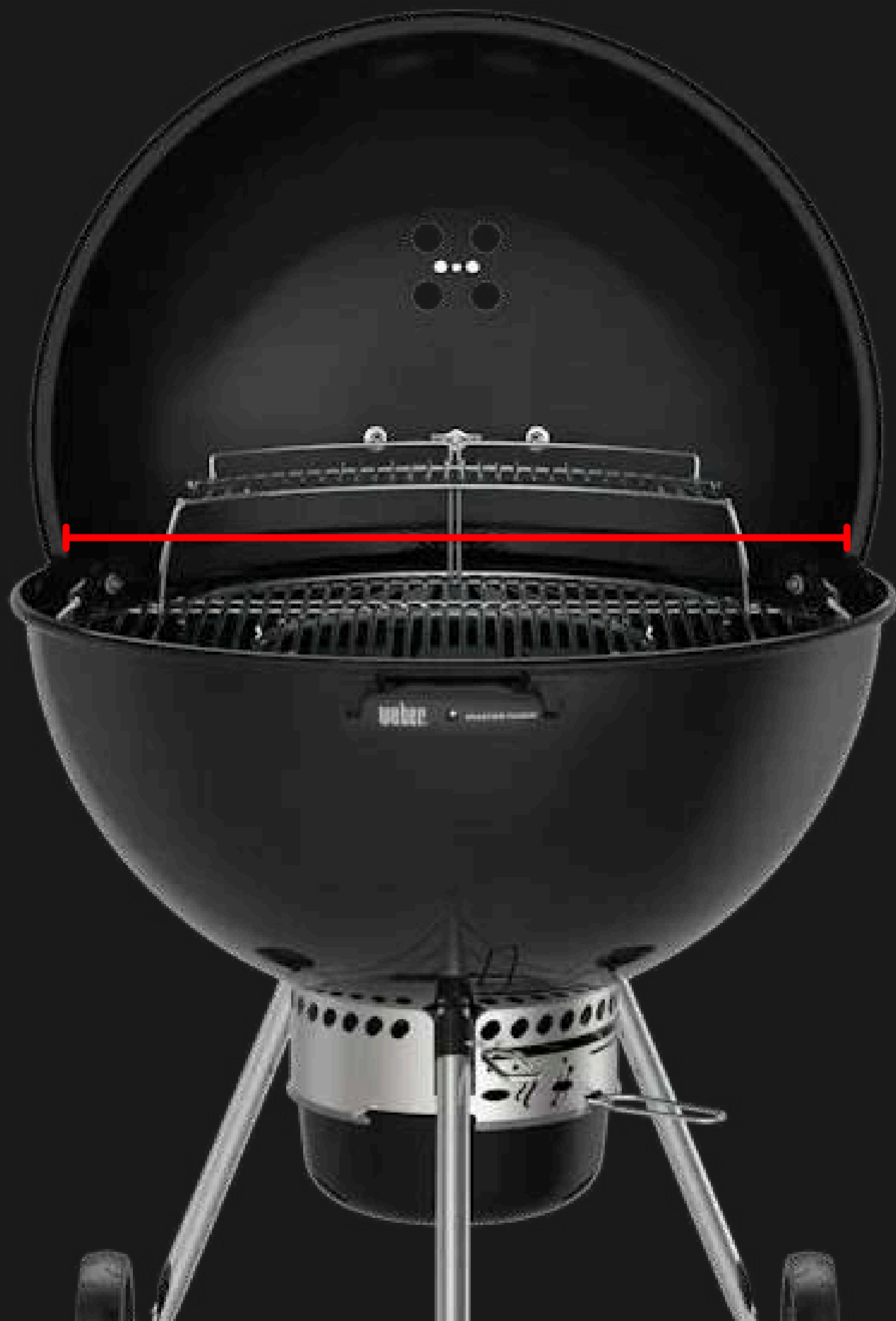

AHORA CON  
**26 PULGADAS**  
DE PARRILLA  
Y AHORA CON SISTEMA



\* ACCESORIOS SE VENDEN  
POR SEPARADO.





BLACK  
1500064



**MASTER TOUCH**  
GBS 26''  
Q7,800



**SOLD OUT**



**CARBÓN**



7666



**DIFUSOR DE CALOR  
Q1,100**

**ASADO DIRECTO  
A FUEGO ALTO**  
Sobre el cono

**ASADO INDIRECTO**  
alrededor del cono

**ASADO A FUEGO  
LENTO Y BAJO**  
carbón al rededor del cono

DISPONIBLE EN TIENDAJUNGLA.COM\*\*



**CARBÓN**



7433

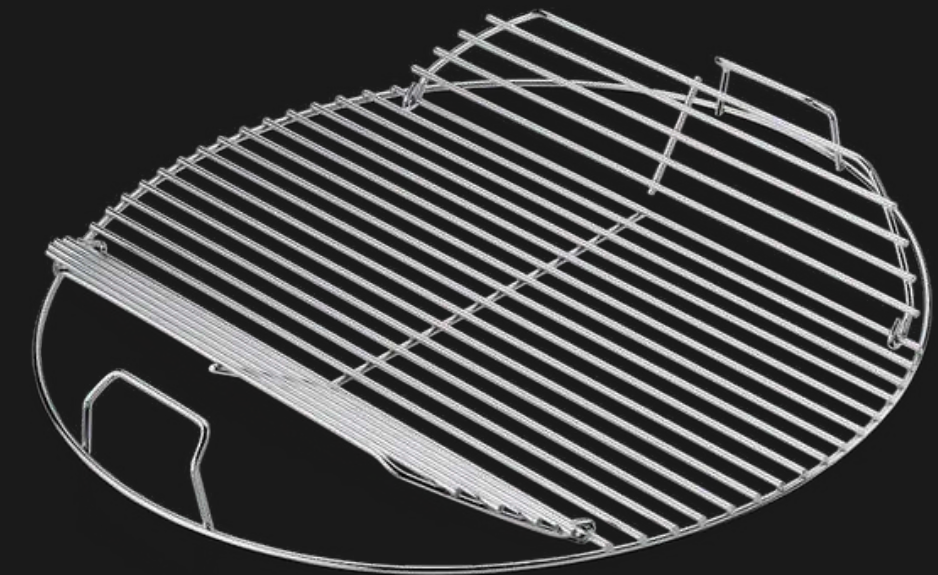

**HINGED COOKING GRATE  
Q325**

Compatible con parrillas de  
carbón de 18"



**CARBÓN**



# MASTER TOUCH Gourmet BBQ System

Adapta diferentes accesorios a tu parrilla y expande las posibilidades

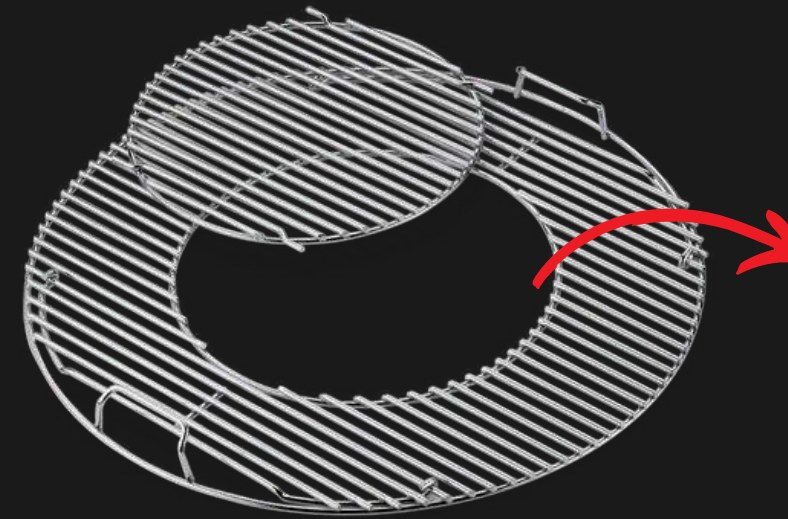

8835  
**PARRILLA INDIVIDUAL**  
GOURMET BBQ SYSTEM COOKING GRATE  
22" de diámetro de parrilla

**SOLD OUT**

Sistema de parrilla ya incluido en Weber Master Touch 22", Performer Black, Performer Dlx y Summit Kamado

GBS - 8838 | Poultry Roaster  
Q900



GBS - 8834 | Sear Grate  
Q700



GBS - 7425 | Wok  
**SOLD OUT**

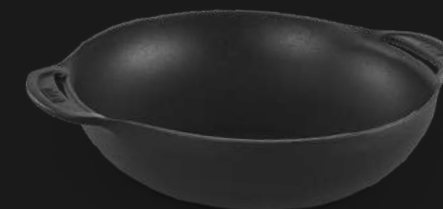

GBS - 7421 | Griddle  
Q700



GBS - 8836 | Pizza Stone  
Q700





PERFORMER BLACK  
Q5,800  
15301001

PERFORMER DELUXE  
Q8,300  
15501001



CARBÓN



**PREMIUM GRILL COVER**  
COMPATIBLE CON CHURRASQUERAS DE CARBÓN 18"

**Q325**  
7148



**PREMIUM GRILL COVER**  
COMPATIBLE CON CHURRASQUERAS DE  
CARBÓN 22" CON MESA PLEGABLE

**Q675**  
7151



**PREMIUM GRILL COVER**  
COMPATIBLE CON PERFORMER DELUXE 22"

**SOLD OUT**  
7152



## SUMMIT KAMADO

PARRILLA Y AHUMADOR DE  
CARBÓN DE 24" PULGADAS

Q18,750

18201001



CARBÓN

*jungla*



SMOKEY MOUNTAIN  
AHUMADOR DE CARBÓN



# Smokey Mountain

Ahumador de carbón de dos niveles con parrilla de carbón y bowl para líquidos





**Smokey Mountain 22"**

**Q7,500**

731001



**Smokey Mountain 18"**

**Q5,750**

721001



**Smokey Mountain 14"**

**Q4,200**

711001



**CARBÓN**



**CHUNKS PARA AHUMAR:**  
MESQUITE - HICKORY - PECAN - CHERRY - APPLE



17148

17150

17137

17142

17139

**CHIPS DE MADERA**  
**PRECIO Q100.00**

**CHUNKS DE MADERA**  
**PRECIO Q150.00**

Searwood

Smoque

*jungla*



PARRILLA Y AHUMADOR DE PELLETS  
ELÉCTRICA



# Searwood

- Rango de temperatura completo de 180° a 600°F para ahumar y asar.
- La cocción **DirectFlame™** crea un efecto dorado, crujiente y sellado.
- La zona para sellar ahora es en toda la parrilla y te permite colocar más comida en la flama.
- **Rapid React™** PID se calienta rápidamente y recupera la temperatura cuando se tapa y se abre.
- La configuración **SmokeBoost™** intensifica el sabor ahumado.
- Cocina con confianza con controles digitales intuitivos en la parrilla y conectividad WIFI y Bluetooth que te permite monitorear y controlar la parrilla de forma remota, ver gráficos en vivo de la cocción, recibes alertas de preparación, recetas y más desde la aplicación WEBER CONNECT desde tu celular o tablet.



### **ASA EN CADA PULGADA**

La sear zone de la rejilla completa se calienta de manera unisma y al máximo de cada centímetro de la parrilla, por lo que obtienes más comida en la llama.



### **COMIDA QUE LUCE BIEN PERO SABE MEJOR**

La cocción DirectFlame™ crea un gran sabor y acabado dorado y crujiente. Sin un gran difusor de láminas que bloqueen la llama, la comida se ve tan bien como sabe con marcas de sellado profundas, dorado y corteza crujiente.



### **AUMENTA EL SABOR AHUMADO**

El ajuste SmokeBoost™ mantiene la temperatura a 180 °F, optimizando la absorción de humo en los alimentos e intensificando el sabor.



# SEARWOOD™ 600 PELLETT GRILL

## Q15,000

1500120



Pellet



# SEARWOOD™ XL 600 PELLET GRILL Q19,200

1500121



Pellet



**weber** | Premium Grill Cover  
Compatible con Searwood 600 pellet

**Q1,400**  
3400145



**weber** | Premium Grill Cover  
Compatible con Searwood XL 600 pellet

**Q1,250**  
3400146



jungla



Weber Smoque™ Pellet Smoker

**AHUMADOR DE PELLETS**



Weber Smoque™ XL Pellet Smoker

**AHUMADOR DE PELLETS**



Searwood™ 600 Pellet Grill

**AHUMADOR Y ASADOR DE PELLETS**



Searwood™ XL 600 Pellet Grill

**AHUMADOR Y ASADOR DE PELLETS**



weber Smoque



weber Searwood

**Características**

Total de espacio de cocción	594 Pulgadas Cuadradas	918 Pulgadas Cuadradas	648 Pulgadas Cuadradas	972 Pulgadas Cuadradas
Rango de temperatura	180–500°F	180–500°F	180–600°F	180–600°F
Opción de sellado			✓	✓
Sistema de cocción	SmoqueVent™ System	SmoqueVent™ System	DirectFlame™ System	DirectFlame™ System
Rapid React™ PID	✓	✓	✓	✓
Opción de Smoke Boost	✓	✓	✓	✓
Termómetro Controlador	Pantalla Digital LCD	Pantalla Digital LCD	Pantalla Grande Digital LCD	Pantalla Grande Digital LCD
Sistema Integrado Wifi and Bluetooth	✓	✓	✓	✓
Compatibilidad Weber Connect	✓	✓	✓	✓
Compatibilidad de mesa lateral o frontal plegable	✓	✓	✓	✓
Compatible a sistema Weber Works	✓	✓	✓	✓
Compatible a sistema Weber Crafted	✓	✓	✓	✓
Compatible con sistema de Plancha empotrable			✓	✓
Compatible con sistema rosticero			✓	✓
Repisa inferior	Se vende por separado	Se vende por separado	✓	✓



**Infundir un sabor profundo y ahumado**  
La función SmokeBoost™ mantiene bajas temperaturas de ahumado, optimizando la absorción del humo en los alimentos e intensificando el sabor.



**Mejora el pardeamiento y la corteza**  
El sistema SmokeVent™ permite que el humo circule alrededor de los alimentos para obtener sabores intensos y un dorado delicioso.



**Ahumar, hornear y asar**  
Desde la cocción lenta a baja temperatura hasta el horneado y el asado, con una amplia gama de temperaturas para preparar costillas ahumadas, falda de res, cecina, pollo asado, platos al horno y guarniciones.



**Llegar a Temp y quedarse allí**  
Ajusta fácilmente la temperatura con el controlador digital LCD Weber Connect®. El sistema Rapid React™ PID calienta el ahumador a la temperatura deseada en 15 minutos o menos\* y recupera el calor rápidamente tras abrir la tapa.



**Control desde cualquier lugar**  
Ahuma desde cualquier lugar con la aplicación Weber Connect®, que te permite supervisar y controlar el ahumador de forma remota mediante conexión Wi-Fi o Bluetooth® y tu smartphone.



**Limpieza sin complicaciones**  
Una vez que hayas terminado de cocinar, el sistema cerrado de gestión de grasa y cenizas te permite limpiar de forma rápida y sencilla, con menos suciedad y sin necesidad de aspiradora.



# SMOQUE™ 22" PELLET GRILL Q11,800

1500770

NEW



Pellet



# SMOQUE™ XL 34" PELLET GRILL Q14,800

1500771



**Pellet**



## SABORES DE PELLETS

GRILLMASTER BLEND - CHERRY - MESTIQUE - HICKORY



**BOLSA DE 20 LBS**  
**PRECIO Q250.00**

*jungla*



**LUMIN**

PARRILLA. CON SISTEMA PARA VAPOR Y AHUMADO  
ELÉCTRICA



## **CORTE SELLADO SIN LLAMA!**

Deja tu corte como de restaurante gracias al rango de temperatura que alcanza hasta los 600 grados!



## **MÁS QUE UNA CHURRASQUERA!**

Puedes cocinar al vapor una guarnición de vegetales e incluso descongelar alimentos con la configuración de vapor exclusiva de Lumin.



## **AGREGA UN TOQUE DE HUMO!**

Con Weber Lumin y la nueva configuración de infusión de humo podrás dejar un toque ahumado en tus cortes, quesos o vegetales.



### **UN BUFFET EN TU TERRAZA!**

Mantén la comida caliente para que tus invitados puedan servirse solos! Weber Lumin posee la opción para mantener caliente tus alimentos.



### **DE CONGELADO A MARCAS DE PARRILLA**

Omite un paso! Con Weber descongelando durante el precalentamiento de la parrilla. Cualquier cosa, desde camarones congelados, nuggets de pollo o incluso mini pizzas.



weber  
**LUMIN**  
Q6,500



Eléctrico



**SOLD OUT**

92010901



91010901

weber  
**LUMIN**  
COMPACT

Q5,750



91400901



Eléctrico





LUMIN  
STAND MEDIUM

Q2,500

CÓDIGO  
6619



LUMIN  
STAND SMALL

Q2,100

CÓDIGO  
6618



BANDEJAS  
PARA SERVIR  
CALIENTE

COCINA A VAPOR  
O AGREGA CHIPS  
DE MADERA

REJILLA PARA  
VEGETALES Y/O  
AHUMADOR

KIT VERSÁTIL MEDIANO

Q1,400

CÓDIGO  
6614



BANDEJAS  
PARA SERVIR  
CALIENTE

COCINA A VAPOR  
O AGREGA CHIPS  
DE MADERA

REJILLA PARA  
VEGETALES Y/O  
AHUMADOR

KIT VERSÁTIL PEQUEÑO

Q1,200

CÓDIGO  
6613



GRIDDLE MEDIUM  
LUMIN

**Q1,250**

CÓDIGO  
6612

GRIDDLE SMALL  
LUMIN

**Q1,000**

CÓDIGO  
6611



**weber** **LUMIN**



*jungla*

**MASTERBUILT**

PARRILLA AHUMADOR DE CARBÓN  
ELÉCTRICA E INTELIGENTE



MASTERBUILT



## ESTANTES FOLDAWAY™

LOS ESTANTES PLEGABLES PROPORCIONAN ESPACIO ADICIONAL PARA COCINAR, MIENTRAS QUE EL ESTANTE FRONTAL DE ACERO INOXIDABLE PROPORCIONA ESPACIO ADICIONAL PARA LA PREPARACIÓN.



## VERSATILIDAD AHUMAR + DORAR

ALCANZA 370°C EN 14 MINUTOS, 230°C EN 10 MINUTOS Y 110°C EN 8 MINUTOS. INCLUYE UN INSERTO DE PLANCHA, PARRILLAS DE COCCIÓN REVERSIBLES DE HIERRO FUNDIDO PARA AHUMAR Y DORAR Y UNA REJILLA DE CALENTAMIENTO O PARA AHUMAR



## DIGITALFAN CONTROL

DIGITALFAN™ PARA UN CONTROL PRECISO DE LA TEMPERATURA. CON SOLO PRESIONAR UN BOTÓN, EL VENTILADOR CONTROLADO DIGITALMENTE MUEVE EL FLUJO DE AIRE DESDE LA TOLVA DE CARBÓN A LA CÁMARA DE COCCIÓN Y MANTIENE LA TEMPERATURA DE COCCIÓN DESEADA.



MASTERBUILT



## MASTERBUILT GRAVITY SERIES XT

PARRILLA Y AHUMADOR

Q25,000

MB20041223



Eléctrico  
y carbón



## QUICKSTART™ AUTO-IGNITION

ELIMINA LA MOLESTIA DE ENCENDER MANUALMENTE EL CARBÓN Y ENCIENDE TU PARRILLA CON SOLO PULSAR UN BOTÓN USANDO EL ENCENDIDO AUTOMÁTICO QUICKSTART™.

¡OBTÉN LA COMODIDAD DE LA PARRILLA DE GAS CON EL SABOR DEL CARBÓN!

## MASTERBUILT WIFI

CONTROLA TU PARRILLA DESDE CUALQUIER LUGAR USANDO LA TECNOLOGÍA WIFI DE MASTERBUILT Y SU APP PARA ESTABLECER Y CONTROLAR LA TEMPERATURA, DESCUBRE NUEVAS RECETAS Y MÁS.

## PLACA DE HIERRO FUNDIDO QUICKSEAR™

¡VERSÁTIL Y DE LIMPIEZA RÁPIDA! CON ELLA PODRÁS DORAR O SALTEAR TUS ALIMENTOS PREFERIDOS DE FORMA PRÁCTICA Y DELICIOSA.

## CHARCOAL MINIHOPPER™

ESTE ALMACENAMIENTO INTERNO PUEDE CONTENER HASTA 5 LIBRAS DE CARBÓN O 7 LIBRAS DE BRIQUETAS, ¡GARANTIZANDO HASTA 8 HORAS DE USO CONTINUO!



MASTERBUILT™



## MASTERBUILT AUTOIGNITE SERIES 545

PARRILLA ELÉCTRICA

Q7,250.00

MB20041124



Eléctrico  
y carbón



MASTERBUILT



# MASTERBUILT GRAVITY SERIES 600

CHURRASQUERA Y AHUMADOR ELÉCTRICO

Q11,250

MB20041023



Eléctrico  
y carbón



## MASTERBUILT WIFI

CONTROLA TU PARRILLA DESDE CUALQUIER LUGAR USANDO LA TECNOLOGÍA WIFI DE MASTERBUILT Y SU APP PARA ESTABLECER Y CONTROLAR LA TEMPERATURA, DESCUBRE NUEVAS RECETAS Y MÁS.

## VERSATILIDAD AHUMAR + SELLAR

INCLUYE REJILLAS DE HIERRO FUNDIDO REVERSIBLES PARA AHUMAR + SELLAR A UN AHUMADO BAJO Y LENTO O PARA SELLAR A ALTA TEMPERATURA

## DIGITALFAN CONTROL

DIGITALFAN™ PARA UN CONTROL PRECISO DE LA TEMPERATURA. CON SOLO PRESIONAR UN BOTÓN, EL VENTILADOR CONTROLADO DIGITALMENTE MUEVE EL FLUJO DE AIRE DESDE LA TOLVA DE CARBÓN A LA CÁMARA DE COCCIÓN Y MANTIENE LA TEMPERATURA DE COCCIÓN DESEADA.



MASTERBUILT



## MASTERBUILT GRAVITY SERIES 800

CHURRASQUERA, PLANCHA Y AHUMADOR ELÉCTRICO

Q12,750  
MB20040221



Eléctrico  
y carbón



**MASTERBUILT**

24"



**COVER FOR GRAVITY SERIES 545**

**Q1,400**  
MB20080220

**COVER FOR GRAVITY SERIES 800**

**Q1,550**  
MB20080221



MASTERBUILT



## MASTERBUILT GRAVITY SERIES 1050

PARRILLA Y AHUMADOR ELÉCTRICO

Q14,000  
MB20041220



Eléctrico  
y carbón



MASTERBUILT®

30"



COVER FOR GRAVITY SERIES 1050

Q1,550  
MB20081220



**MASTERBUILT**

**PORTABLE CHARCOAL  
GRILL WITH CART**

**SOLD OUT**  
Q3,500  
MB20040722



**MASTERBUILT**

**PORTABLE CHARCOAL  
GRILL**

**Q3,000**  
MB20040522





MASTERBUILT



MASTERBUILT  
FIRE STARTERS  
CAJA DE 48 INICIADORES

**SOLD OUT**  
MB20091521



MASTERBUILT

LUMP CHARCOAL  
16LBS.

**SOLD OUT**  
MB20091621



*jungla*

 **KAMADOJOE**

PARRILLA, AHUMADOR & HORNO  
CERÁMICO



 **KAMADOJOE®**

13.5"



**KAMADO JOE JR**

**Q6,250.00**  
KJ13RH



**Carbón**



## PREMIUM GRILL COVER

COBERTOR PARA KAMADO JR

**Q750**

KJ15080420



## SOAPSTONE FOR JOE JR

IDEAL PARA UNA VARIEDAD DE ALIMENTOS, INCLUIDOS PESCADO, CARNES Y VERDURAS, LA SUPERFICIE DE COCCIÓN DE ESTEATITA ES ANTIBACTERIANA Y RESISTENTE A LAS MANCHAS.

**Q1,250**

KJ15090720



## JOE JR CART WITH SHELVES

**Q3,250**

KJ15112524



 **KAMADOJOE**

18"



**CLASSIC JOE™ GRILL - SERIES II**

**SOLD OUT**

**KJ23RHC**



**Carbón**

CONFIRMAR EXISTENCIAS . PRECIOS SUJETOS A CAMBIOS



 **KAMADOJOE**

18"



**CLASSIC JOE™ GRILL - SERIES III  
STAND ALONE**

**Q20,000.00**  
KJ15040721



**Carbón**



 **KAMADOJOE**

18"



**CLASSIC JOE™ GRILL - SERIES III**

**Q25,000.00**

KJ-15040921



**Carbón**

CONFIRMAR EXISTENCIAS . PRECIOS SUJETOS A CAMBIOS



 **KAMADOJOE**

18"



**GRILL COVER FOR CLASSIC JOE**

**Q1,250.00**  
**KJ-GC23BWFS**



 **KAMADOJOE**



Eléctrico  
y carbón



**KONNECTED JOE 18"**

**SOLD OUT**

KJ15041123

[> CONOCE MÁS](#)

CONFIRMAR EXISTENCIAS . PRECIOS SUJETOS A CAMBIOS



 **KAMADOJOE**

24"



**BIG JOE™ GRILL - SERIES II**

**SOLD OUT**

**BJ24RHC**



**Carbón**

CONFIRMAR EXISTENCIAS . PRECIOS SUJETOS A CAMBIOS



 **KAMADOJOE**

24"



**BIG JOE™ GRILL - SERIES III**

**Q37,750.00**

KJ-15041021



**Carbón**



 **KAMADOJOE**

24"



**GRILL COVER FOR BIG JOE**

**Q1,500.00**

**BJ-GC24BWFS**

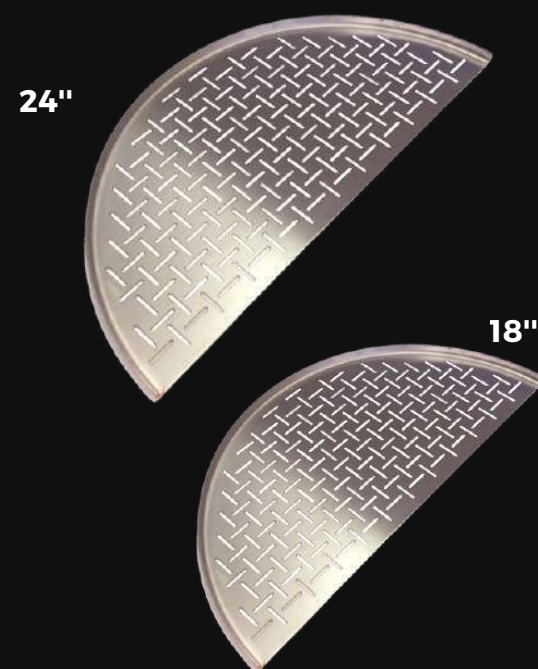

### Half Moon SS

Media luna de acero inoxidable para cocción de vegetales y mariscos

Classic Joe II 18" - **Q1,750**

Big Joe II 24" - **Q1,250**

KJ-HSSCGFV BJ-HSSCGFV



### Chicken Stand

**Q250**

KJ-CS

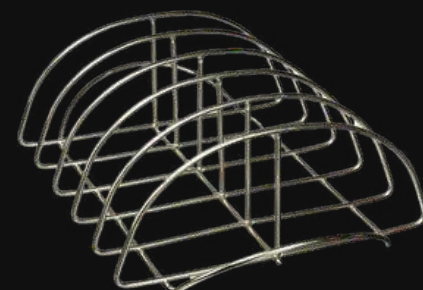

### Rib Rack

Soporte para costillas, espacio para 5 racks

**SOLD OUT**

KJ-RR



### Kamado Joe BIG BLOCK - XL Lump Charcoal - 20 lbs

Rinde hasta 16 horas

**SOLD OUT**

KJCHAR



### Kamado Joe - Chunks -10 lbs

Hickory  
Apple  
Maple  
Pecan  
Oak

**Q250**

KJ-WCHUNKS



### Kamado Joe - Fire Starters

Caja de 24 iniciadores

**Q175**

KJ-FS



24"

18"

Ideal para una variedad de alimentos, incluidos pescado, carnes y verduras, la superficie de cocción de esteatita es antibacteriana y resistente a las manchas, por lo que nunca tendrá que preocuparse por la contaminación cruzada o la limpieza desordenada.

La gruesa losa de esteatita canadiense distribuye el calor de manera uniforme y mantiene los jugos dentro de la carne para una comida llena de sabor.

La superficie de esteatita también inhibe los brotes, lo que significa menos carne quemada y mayor seguridad

## SOAPSTONE

JOE JR - Q1,250

18" - Q1,500

24" - Q2,000

KJ-HCGSTONE BJHCGSTONE

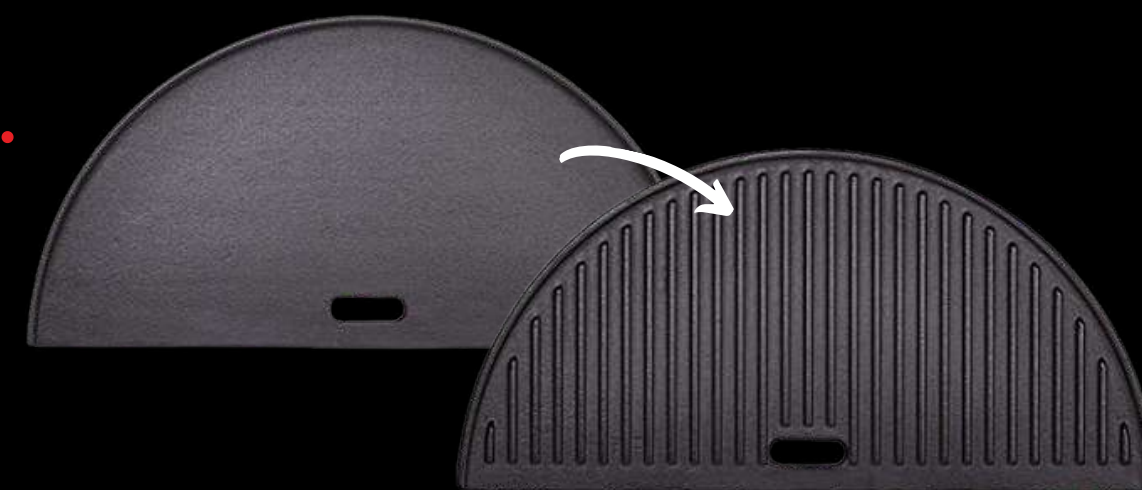

Plancha de dos caras ofrece una superficie lisa y una superficie acanalada, perfecta para todas las cocciones de hierro fundido. Mezcle y combine diferentes superficies para adaptarse a cualquier necesidad y estilo.

La plancha de doble cara ofrece una superficie lisa y una superficie acanalada El hierro fundido ofrece una excelente retención de calor y es muy resistente. Para usar con el sistema de cocción flexible Divide & Conquer Disponible para los modelos Classic y Big Joe

## REVERSIBLE GRILL & GRIDDLE

Classic Joe II 18" - Q1,000

Big Joe II 24" - Q1,250

BJ-HCIGRIDDLE KJ-HCIGRIDDLE



24"



18"

El hierro fundido es ideal para todos los cortes, y las abundantes marcas de rejilla doran las carnes y sellan el sabor. Mezcle y combine diferentes superficies para adaptarse a cualquier necesidad y estilo.

## CAST IRON HALF MOON GRATE

Classic Joe II 18" - Q900

Big Joe II 24" - **SOLD OUT**

KJ-HC1CG BJ-HC1CG



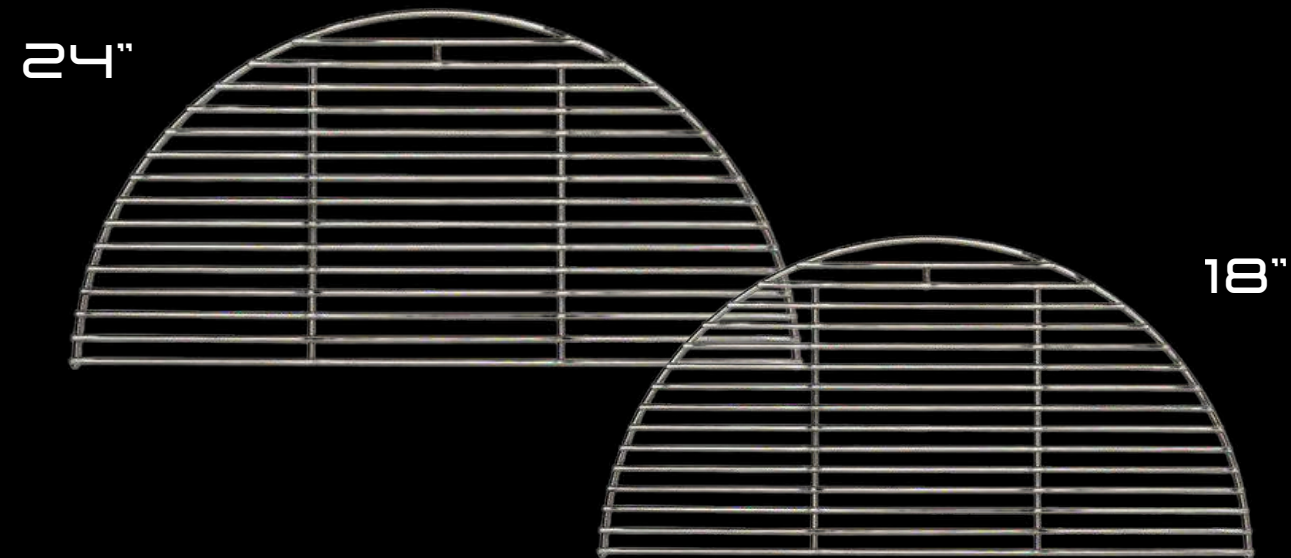

El hierro fundido es ideal para todos los cortes, y las abundantes marcas de rejilla doran las carnes y sellan el sabor. Mezcle y combine diferentes superficies para adaptarse a cualquier necesidad y estilo.

## HALF-MOON STAINLESS STEEL COOKING GRATE

Classic Joe II 18" - Q600

Big Joe II 24" - Q775

KJ-HCG BJ-HCG





Resistente e innovadora superficie de cocción de acero inoxidable que evita que se pegue a los alimentos, lo que facilita mantener intactos los filetes de pescado enteros, y las ranuras tienen un tamaño específico para evitar que las verduras se caigan. La superficie proporciona una distribución uniforme del calor, mientras que las ranuras crean marcas de parrilla perfectas para el enchapado.

REJILLA DE ACERO INOXIDABLE PARA PESCADO Y VERDURAS

Classic Joe II 18" - Q1,750

Big Joe II 24" - Q1,250

KJ-HSSCGFV BJ-HSSCGFV



19.75"



15"

El deflector de calor Kamado Joe de cerámica le permite crear zonas de calor en su parrilla kamado, que bloquea parcialmente el calor para proporcionar una llama abierta e indirecta. Mezcle y combine diferentes superficies para adaptarse a cualquier necesidad y estilo.

PLACA DEFLECTORA DE MEDIA LUNA  
(JUEGO DE 2)

Classic Joe II 15" - **SOLD OUT**

Big Joe II 19.75" - Q975

BJHDP KJ-HDP





Sentado directamente sobre la rejilla de la parrilla con un generoso espacio libre de cuatro pulgadas. Consigue diferentes niveles de temperatura en una misma cocción

## GRILL EXPANDER

Classic Joe II 18" - Q1,000

Big Joe II 24" - Q1,750

KJ-SCS BJSCS



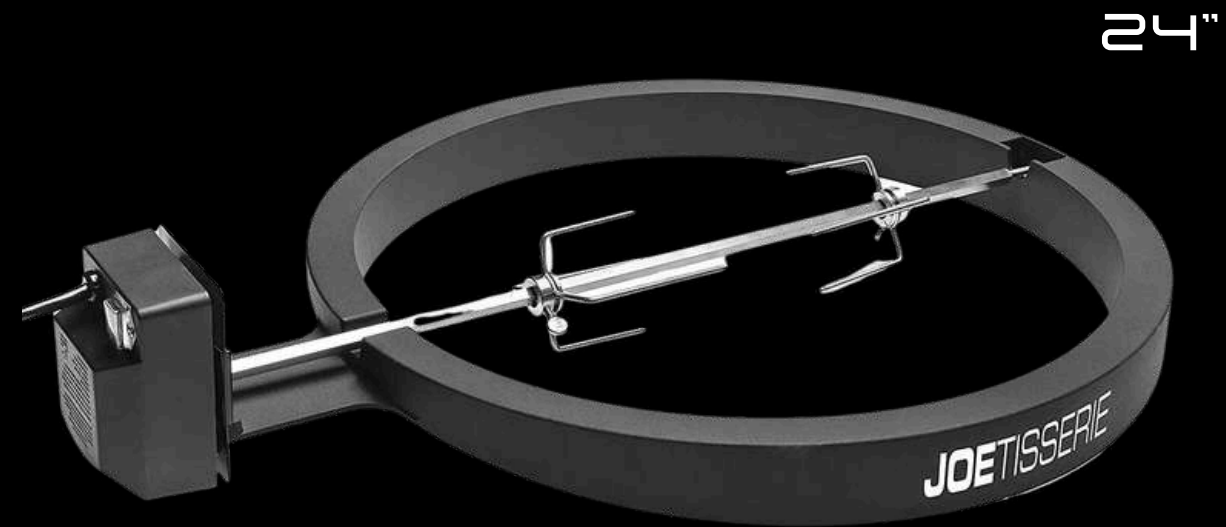

Ajustables para un equilibrio perfecto y una rotación constante. Gire hasta 50 libras de carne de res, cerdo o pollo con un potente y silencioso motor de 120V. El kit de asador es fácil de instalar

JOETISSERIE

Classic Joe II 18" - Q3,750

Big Joe II 24" - Q4,500

KJ-TISSERIENA BJ-TISSERIENA





Una de las últimas innovaciones, el duradero aluminio fundido DōJoe transforma su Kamado Joe en el mejor horno para pizza de su clase. Ideal para principiantes y chefs expertos por igual, la forma de cuña distintiva del DōJoe hace que mantener temperaturas constantes que oscilen entre 400 ° F y 700 ° F sin esfuerzo

**DŌJOE**

**Classic Joe II 18" - Q4,000**

**Big Joe II 24" - Q4,500**

KJ-DJ BJDJ



Con un borde plano de madera diseñado para deslizarse debajo de la base de la pizza para un chapado sin esfuerzo, el Kamado Joe Pizza Peel es la herramienta ligera perfecta para servir.

**PIZZA PEEL**

**Q250**

KJ-PP





Kamado Joe Deep Dish pizza te permite servir con calidad de pizzería, así como paella, guisos y pan.

## DEEP DISH PIZZA

**Q600**

KJ-DDPS





Hecha de cerámica resistente, esta piedra para pizza está hecha para durar y también es fácil de limpiar.

## CERAMIC PIZZA STONE

Classic Joe II 18" - Q1,000

Big Joe II 24" - Q1,250

KJ-PS23 BJPS24





Cocina guarniciones, postres, mariscos, salsas y un sin fin de opciones en tu churrasquera con el Wok de Kamado Joe.

**HARBON STEEL WOK**

**Q1,750**

KJ15124922





Excelente retención de calor y durabilidad, el hierro fundido es ideal para dorar y sellar.

SEAR PLATE

Q725

KJ15090620





**PIT**   
**BARREL**  
COOKER CO.®

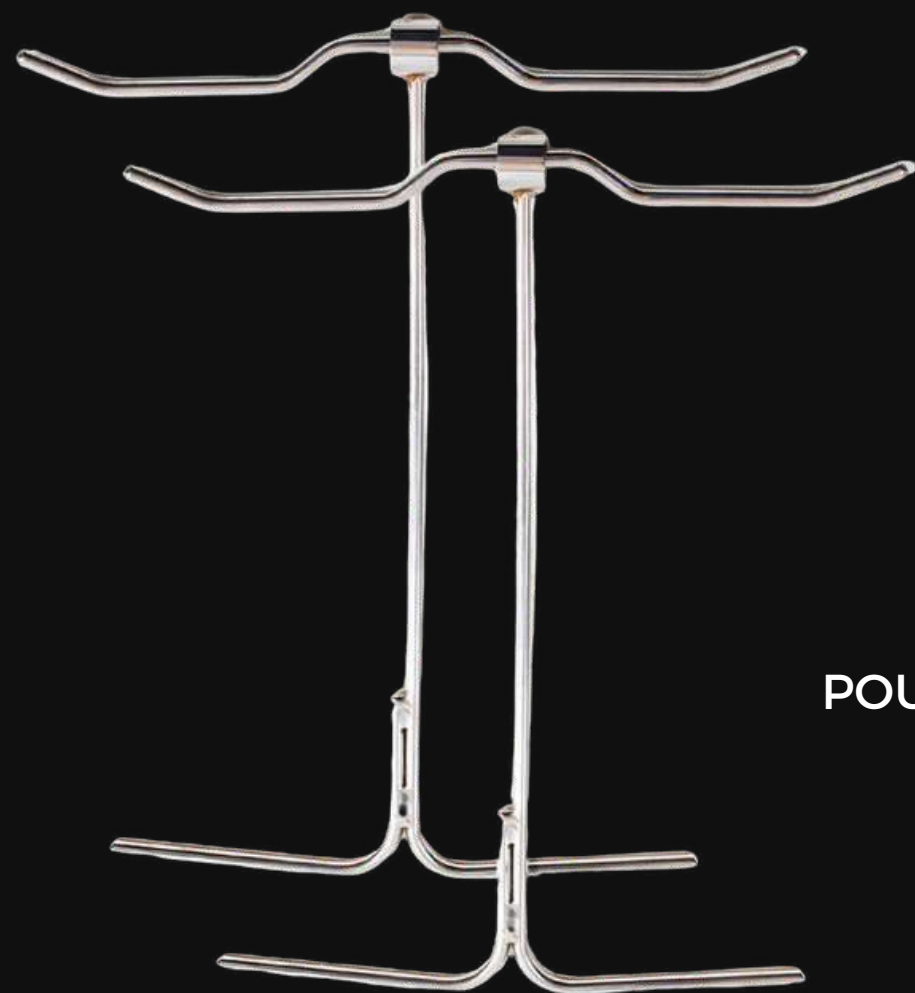

POULTRY HANGER  
**Q300**  
AC1008

COCINAR AVES NUNCA HA SIDO TAN FÁCIL GRACIAS A LOS PULTRY HANGER DE ACERO INOXIDABLE. OLVIDA QUE TUS AVES CAIGAN EN LAS BRASAS NI DE TENER QUE DESHUESARLAS PARA ABRIRLAS.

SOLO TIENES QUE RETIRAR UNA DE LAS VARILLAS AL BAJAR EL PAVO Y VOLVER A COLOCARLA PARA APOYAR EL COLGADOR .



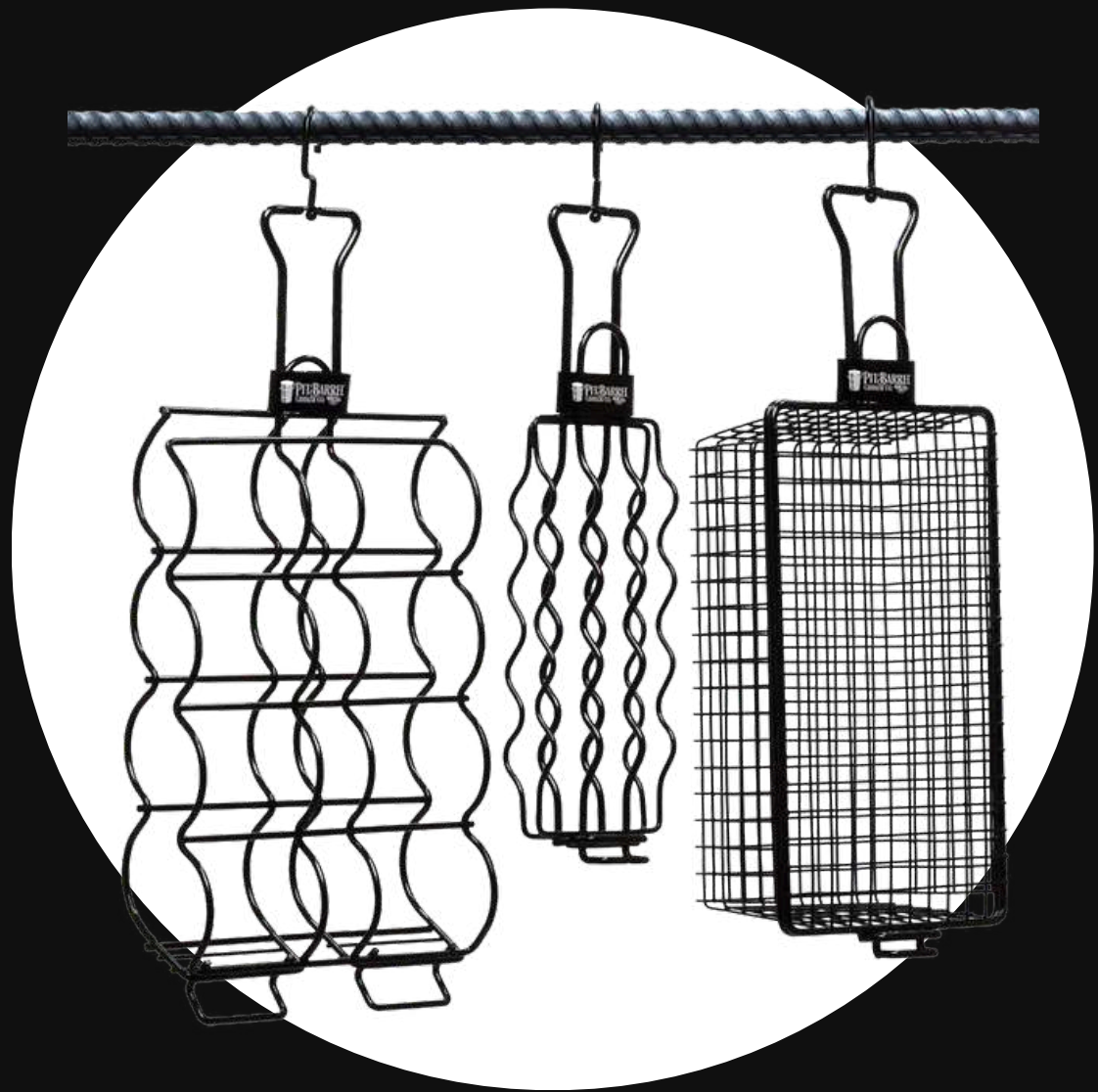

3-HANGER PACK  
**Q500**  
AC1014VAL

AHORA PUEDE COCINAR SUS GUARNICIONES  
SIMULTÁNEAMENTE CON LA CARNE QUE PREFIERA SIN LA  
MOLESTIA DE ESTAR PENDIENTE DE LA ESTUFA O EL HORNO.  
SEA CUAL SEA SU PREFERENCIA: PAPAS, MAÍZ, ESPÁRRAGOS,  
PASTEL DE CARNE O SALCHICHAS,

EL PAQUETE DE 3 PERCHAS ES LA SOLUCIÓN INTEGRAL  
PARA UNA COMIDA PERFECTA.





AC1014AP

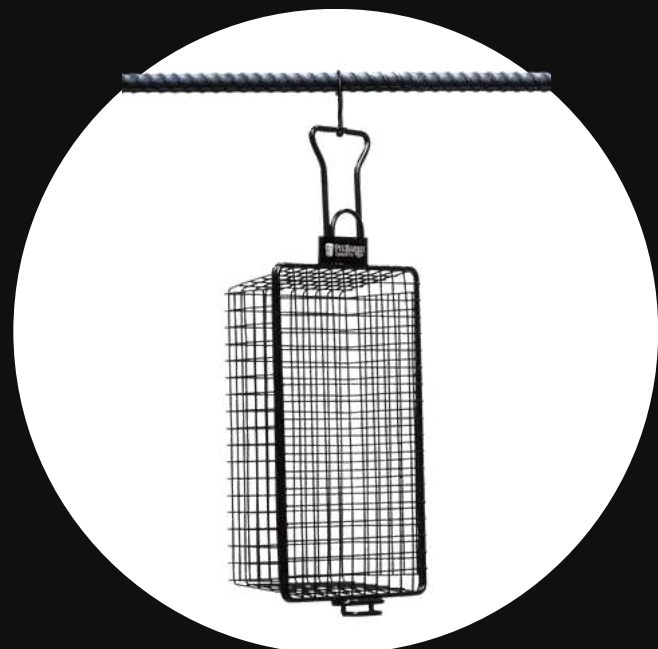

**ALL-PURPOSE BASKET HANGER**

**Q225**



AC1015L10

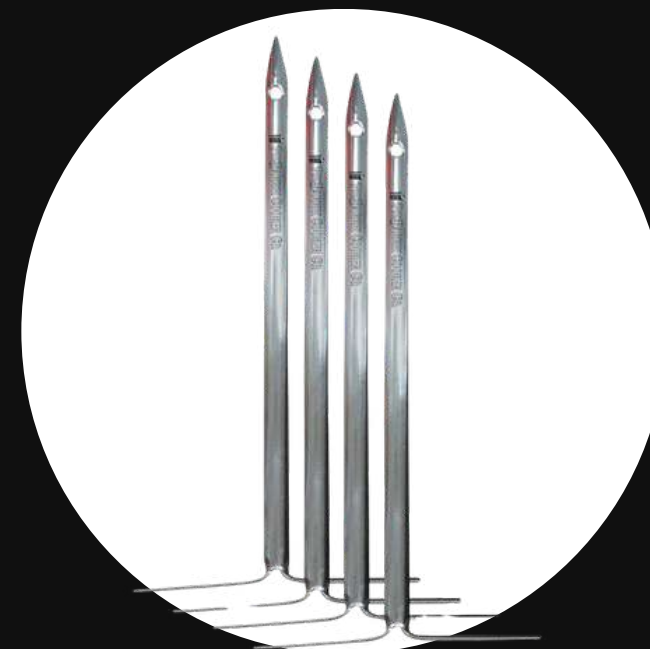

**STAINLESS STEEL 10" HANGING  
SKEWERS (4-PACK)**

**Q250**



AC1015L15



**STAINLESS STEEL 15" HANGING  
SKEWERS (2-PACK)  
Q225**

AC1003D



**STAINLESS STEEL HOOK TOOL  
Q250**

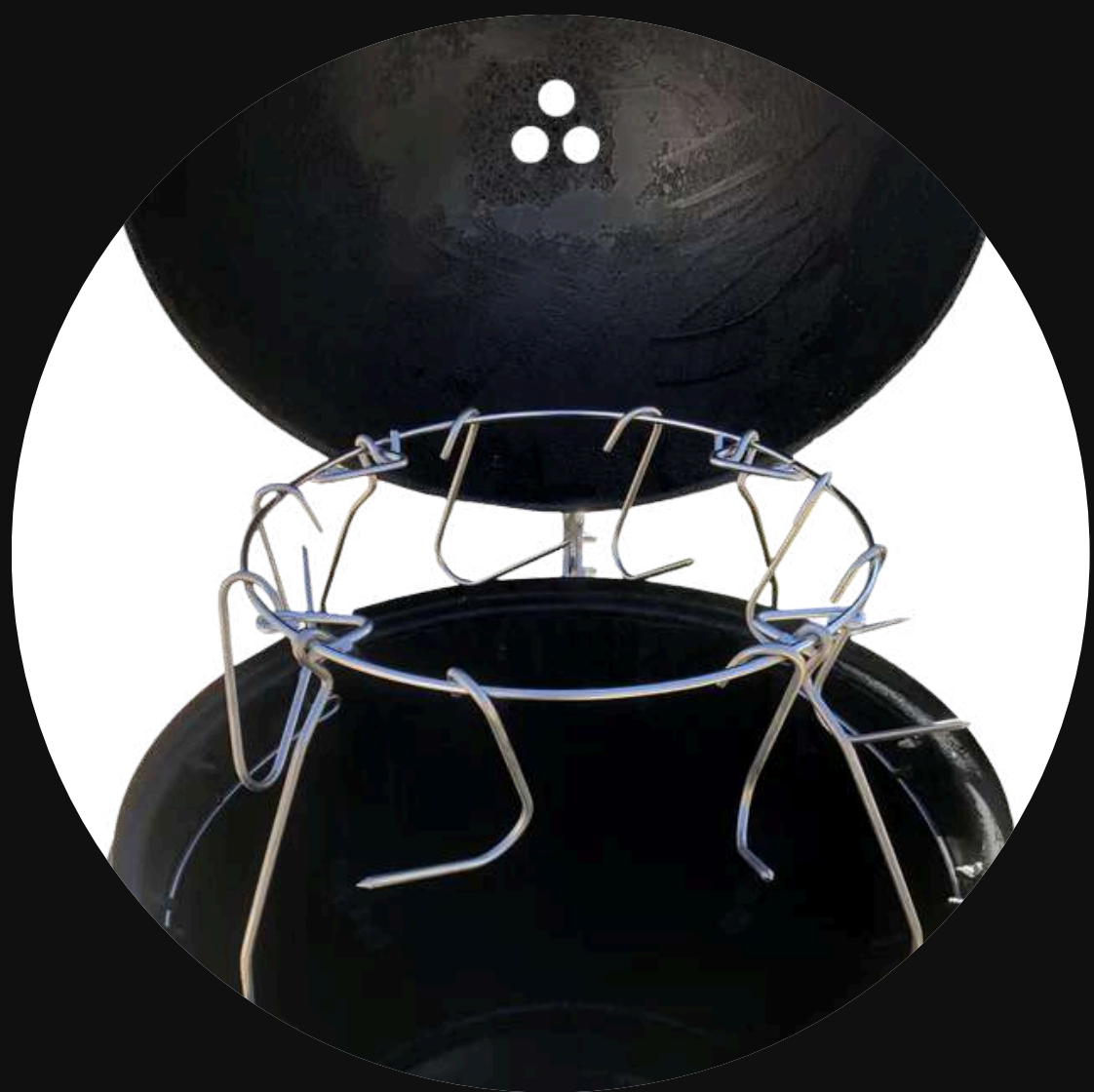

18" WEBER  
SMOKEY  
MOUNTAIN  
HANGING SYSTEM

**Q550**  
WSM1001

EL SISTEMA DE SUSPENSIÓN WSM ES UNA INNOVACIÓN PARA LOS FANÁTICOS DEL WEBER SMOKEY MOUNTAIN.

EL SISTEMA DE SUSPENSIÓN WEBER SMOKEY MOUNTAIN SE FIJA FÁCILMENTE EN LOS SOPORTES SUPERIORES DE LA PARRILLA, LO QUE FACILITA COCINAR UNA GRAN CANTIDAD DE SUS CORTES FAVORITOS. EL SISTEMA DE SUSPENSIÓN WEBER SMOKEY MOUNTAIN PERMITE UNA MAYOR CAPACIDAD DE COCCIÓN,



*GB* GrillBlazer





SU-VGUN GRILLBLAZER

**Q2,650**

SU-VGUN



UTILICE UN SU-VGUN PARA SELLAR SU CARNE COCINADA AL VACÍO, FLAMEAR SU CRÈME BRÛLÉE O ENCENDER SU PARRILLA DE CARBÓN MÁS RÁPIDO DE LO QUE PODRÍA SI ESTUVIERA COCINANDO EN UNA PARRILLA A GAS.

EL SU-VGUN ES UN SOPLETE DE PROPANO DE ALTA POTENCIA, DISEÑADO PARA SELLAR SU CARNE MÁS RÁPIDO Y MEJOR QUE CUALQUIER OTRO SOPLETE DISPONIBLE. POSEE UN SOPORTE DE BOTELLA PRÁCTICO QUE LE PERMITE COLOCAR SU SU-VGUN CONECTADO A UNA BOTELLA DE PROPANO, EN POSICIÓN VERTICAL Y DE FÁCIL ACCESO MIENTRAS SE ENFRÍA DESPUÉS DE HABERLO USADO.



*jungla*

G A S G R I L L S

GENESIS



*jungla*

**weber** | TRAVELER





Gas

weber  TRAVELER

Q6,250

9010001



Funciona con  
cilindro desechable  
de 1 lb o consulta por  
el adaptador  
a gas de 20 lbs

perfecta para viajes!



Compacta y portátil



7031

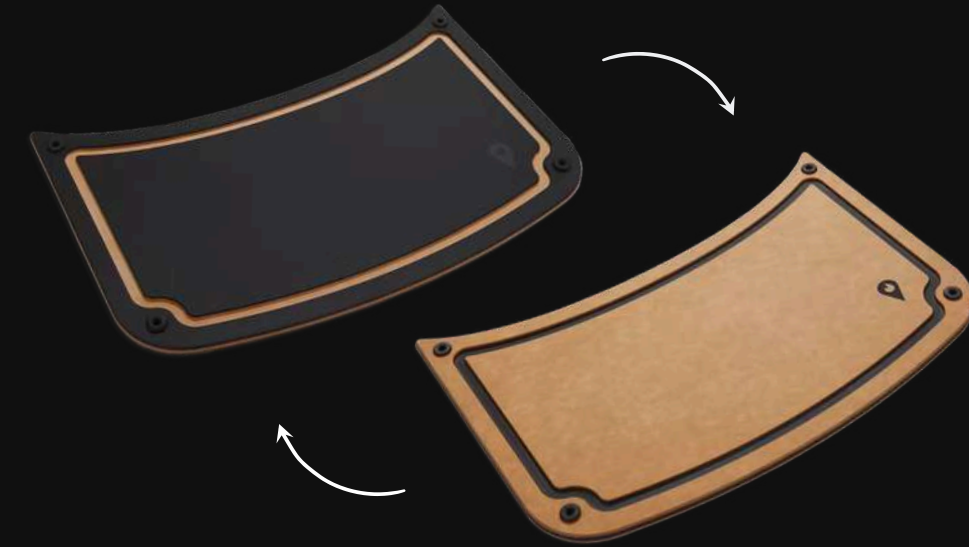

**weber TRAVELER**  
Reversible Prep & Serve  
**Q500**

7030



**weber TRAVELER**  
Cargo Protector  
**Q750**



*jungla*



**weber** | SERIE Q

*jungla*

Alimenta tu  
**Q**uriosidad

Conoce la nueva  
**Q Series 2800**

Tapa de domo alto: Admite alimentos más grandes como pollos enteros.

El amplio rango de temperatura de 250° - 700°F brinda más formas de asar.

Bandeja extraíble mejorada

El quemador adicional (+) te permite alcanzar y mantener temperaturas extra altas o bajas





## Q 2800N+ GAS GRILL

2 QUEMADORES

**Q6,000**

1500375/7

Hasta 10  
cuotas sin  
recargo



Gas



# Q 2800N+ GAS GRILL

CON CARRITO

## Q8,500

1500390

Hasta 10  
cuotas sin  
recargo



Gas



**weber** | Inserto Plancha

Compatible con  
Q 2800N+

**Q1,900**

3400248

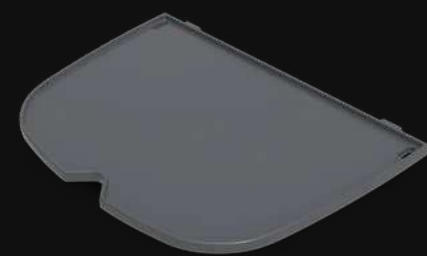

**weber** | Inserto Media Plancha

Compatible con  
Q 2800N+

**SOLD OUT**

3400247



**weber** | Compact Stand

Compatible con Series Q

**Q1,325**

3400262



**weber** | Portable Cart

Compatible con Series Q

**Q1,750**

3400263



**weber** | Cover for Q 2800N+

**Q450**

3400232



**weber** | Cover for Q 2800N+

Compatible con Q 2800N+ con carrito

**Q1,000**

3400233

*jungla*



**weber** | SERIE SPIRIT



Gas



**SPIRIT™** EP-325

SOLD OUT

1500792

2 QUEMADORES BOOST LIBERAN UN 40 % MÁS  
DE POTENCIA EN LA ZONA DE COCCIÓN  
EL TERMÓMETRO DIGITAL LE PERMITE VER LA TEMPERATURA  
PRECISA DE DÍA Y DE NOCHE  
LA MESA LATERAL WEBER WORKS™ SE ADAPTA A INSERTOS  
EMPOTRABLES (SE VENDEN POR SEPARADO)



ÚLTIMA EXISTENCIA DISPONIBLE EN JUNGLA ZONA 10 . PRECIOS SUJETOS A CAMBIOS



**SPiRiT**™ E-210

**Q8,250**

1501000



**SPiRiT**™ E-325

**Q9,750**

1500789



**SPiRiT**™ E-425

**Q11,750**

1500780



Gas



Gas



**SPIRIT™** E-435  
**Q13,500**

1500782

- 2 QUEMADORES BOOST CON HASTA 40 % MÁS POTENCIA EN LA ZONA DE SELLADO.
- 4 QUEMADORES PRINCIPALES + QUEMADOR LATERAL.
- ENCENDIDO SNAP-JET EN CADA QUEMADOR.
- ÁREA TOTAL DE COCCIÓN DE 533 IN<sup>2</sup>.
- SISTEMA DE GESTIÓN DE GRASA DE FÁCIL LIMPIEZA.
- COMPATIBLE CON ACCESORIOS WEBER WORKS™ (SE VENDEN POR SEPARADO).



SPIRIT & PELLET 24IN ROTISSERIE

**Q1,750**

3400252

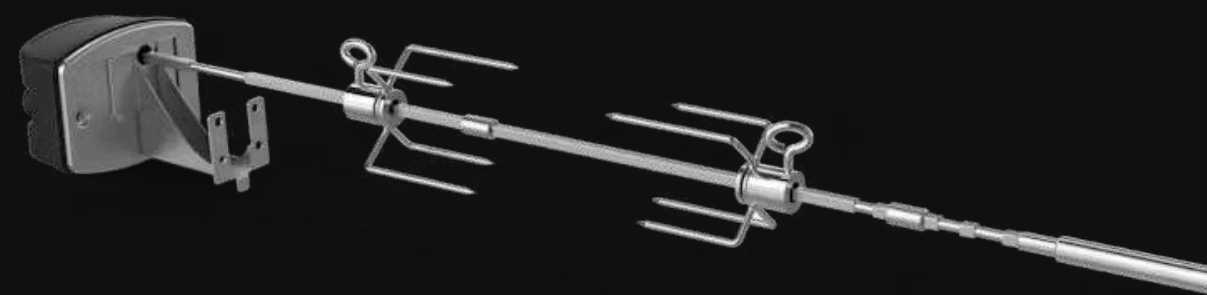

- ASA A FUEGO LENTO DESDE UN POLLO ENTERO CRUJIENTE Y JUGOSO HASTA UN TIERNO LOMO DE CERDO. EL ROSTICERO GIRA SUAVEMENTE LOS ALIMENTOS SOBRE LA REJILLA, PRODUCIENDO CARNE JUGOSA.
- PINCHOS DE ASADOR DISEÑADOS PARA CORTES GRANDES Y PEQUEÑOS DE CARNE
- INCLUYE EJE, TENEDORES, MANGO Y HERRAJES DE ACERO INOXIDABLE
- COMPATIBLE CON PARRILLAS DE PELLETS SEARWOOD® 600 Y PARRILLAS DE GAS SPIRIT
- MOTOR ELÉCTRICO DE ALTA RESISTENCIA



¡Convierte tu churrasquera  
En plancha!



**GRIDDLE SPIRIT II**  
**3 QUEMADORES**

**Q3,250.00**  
6787

- Parrillas de gas Spirit de 4 quemadores fabricadas desde 2025
- Parrillas de gas Spirit/Spirit II de 3 quemadores fabricadas entre 2016 y 2024
- Parrillas de pellets Searwood®

*jungla*



**weber** I SERIE GENESIS



# GENESIS

¿QUÉ INCLUYE?

- Nuevas mesas laterales Extra Grandes
- Nueva Zona de sellado Extra Grande
- Rejilla de cocción superior extensible
- Quemadores **PureBlu** de alto rendimiento
- WEBER CRAFTED Rejillas de cocción de acero inoxidable de 7 mm de diámetro o Parrillas de cocción de hierro fundido esmaltado en porcelana
- Nuevo marco Weber Crafted
- Quemador lateral
- Casillero lateral extra grande



Hierro fundido



Acero Inox.



Las nuevas parrillas de las churrasqueras Genesis traen el sistema Gourmet que te permite retirar la parrilla y empotrar diferentes accesorios para expandir tus recetas.

## NUEVO SISTEMA DE LIMPIEZA

Ahora la limpieza es mucho más fácil. Puedes extraer totalmente ambas bandejas atrapa grasa.

## NUEVO MESAS LATERALES

Las nuevas Genesis ahora tienen mesas laterales mucho más grandes para que puedas colocar lo que necesites para facilitar tus asados.



## CASILLERO EXTRA GRANDE

Creado para  
almacenar todos los  
accesorios del sistema  
Weber Crafted



## ESTACIÓN DE SELLADO

Área de calor intensa y  
uniforme, para crear esas  
perfectas marcas de parrilla en  
tus cortes.

Sear Zone o Estación de sellado  
se calienta mucho más rápido  
que el resto de las demás  
partes de la parrilla.



## COLGADOR PARA PARRILLA

Cuando estés  
utilizando el sistema  
de Weber Crafted  
puedes colgar tu  
parrilla al lateral de  
tu Genesis.



## PARRILLA EXPANSIBLE

¡Ahora puedes usar la  
parrilla inferior para crear  
un segundo nivel de  
cocción!



**weber**  
**GENESIS S-335**  
**Q22,000**  
**3 Quemadores**  
**Acero Inoxidable**  
1500537

**weber**  
**GENESIS S-435**  
**SOLD OUT**  
**4 Quemadores**  
**Acero Inoxidable**  
36400001



Gas

[»» Conoce más](#)



Gas



**GENESIS E-325**

**Q16,000**

1500533

CONFIRMAR EXISTENCIAS . PRECIOS SUJETOS A CAMBIOS



**weber**  
**GENESIS E-315**  
**Q15,250**  
1500010



**weber**  
**GENESIS E-415**  
**Q19,500**  
1500367



Gas

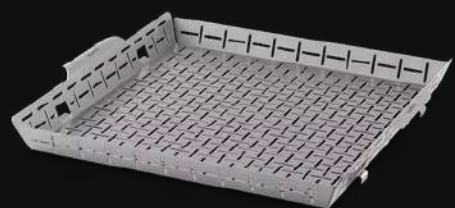

### **CESTA DE VEGETALES**

Perfecta para asar vegetales, frutas, nueces, mariscos delicados y trozos de carne más pequeños.

**Q1,250**

Medidas 17.2 x 16.3"

7673



### **PLANCHA**

Ideal para fajitas, desayunos y muchas otras recetas a la plancha.

**Q1,250**

Medidas 15.8 x 16.3"

7672



### **PARRILLA SELLADORA**

La favorita para dejar el sellado de restaurante en tus cortes favoritos.

**Q1,500**

Medidas 16 x 16.3"

7670



### **PIEDRA PARA HORNEAR**

Piedra con acabado antiadherente que ayuda a evitar que los alimentos se peguen. Cocina pizzas, pan y galletas sin problema!

**Q1,250**

Medidas 16 x 16.3"

7671



Crea comida que nunca hubieras pensado posible en tu parrilla, con la colección de cocina al aire libre WEBER CRAFTED. Haga arroz salteado y frito en el wok o use la cesta de vapor para cocer al vapor verduras y albóndigas

## WEBER CRAFTED WOK & STEAMER

**Q2,000**

7606

\*\*COMPATIBLE CON GENESIS Y SPIRIT 2016+ GAS GRILLS Y SMOKEFIRE EX4 WOOD PELLET GRILLS

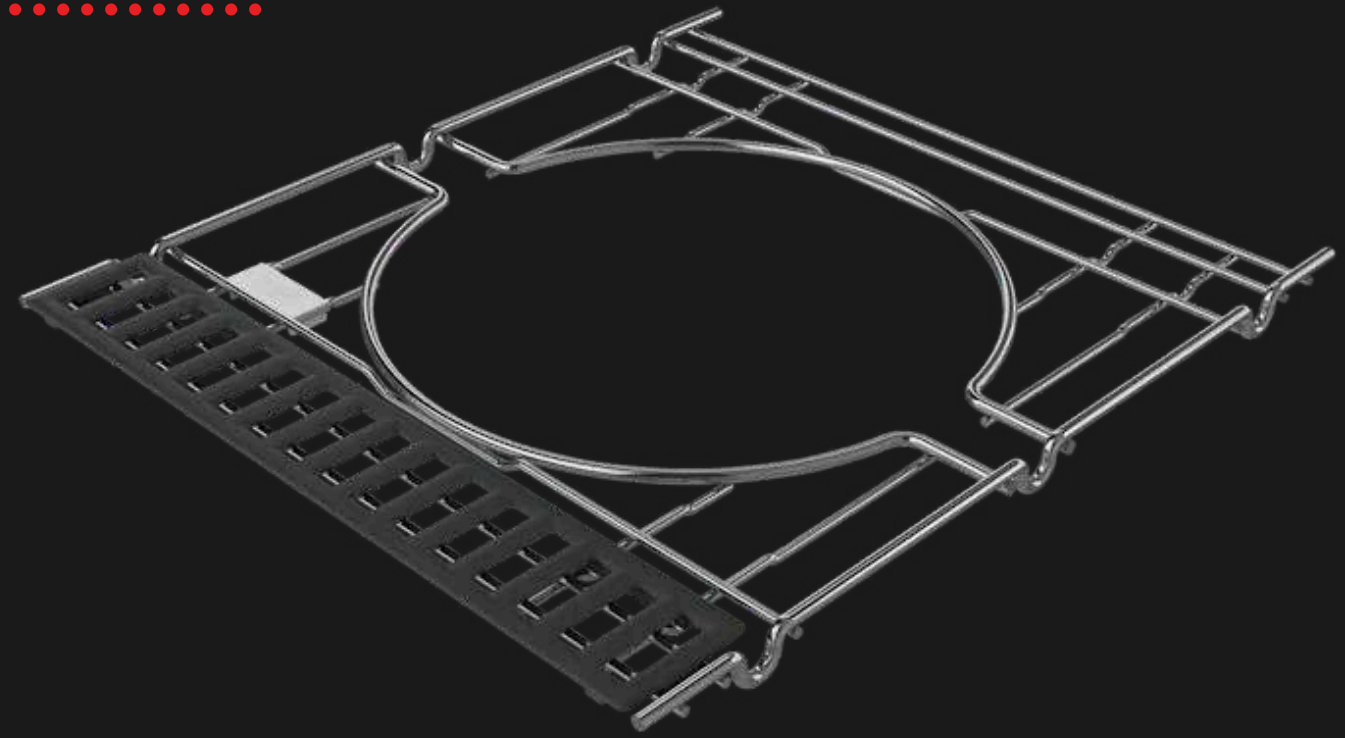

Simplemente reemplace su rejilla de cocción del lado derecho con el marco WEBER CRAFTED para desbloquear nuevas posibilidades de asar a la parrilla.

**WEBER CRAFTED FRAME KIT -  
GENESIS**

**Q700**

7677

**\*\*COMPATIBLE CON GENESIS  
E-325S/EX-325S/S-325S/SX-325**

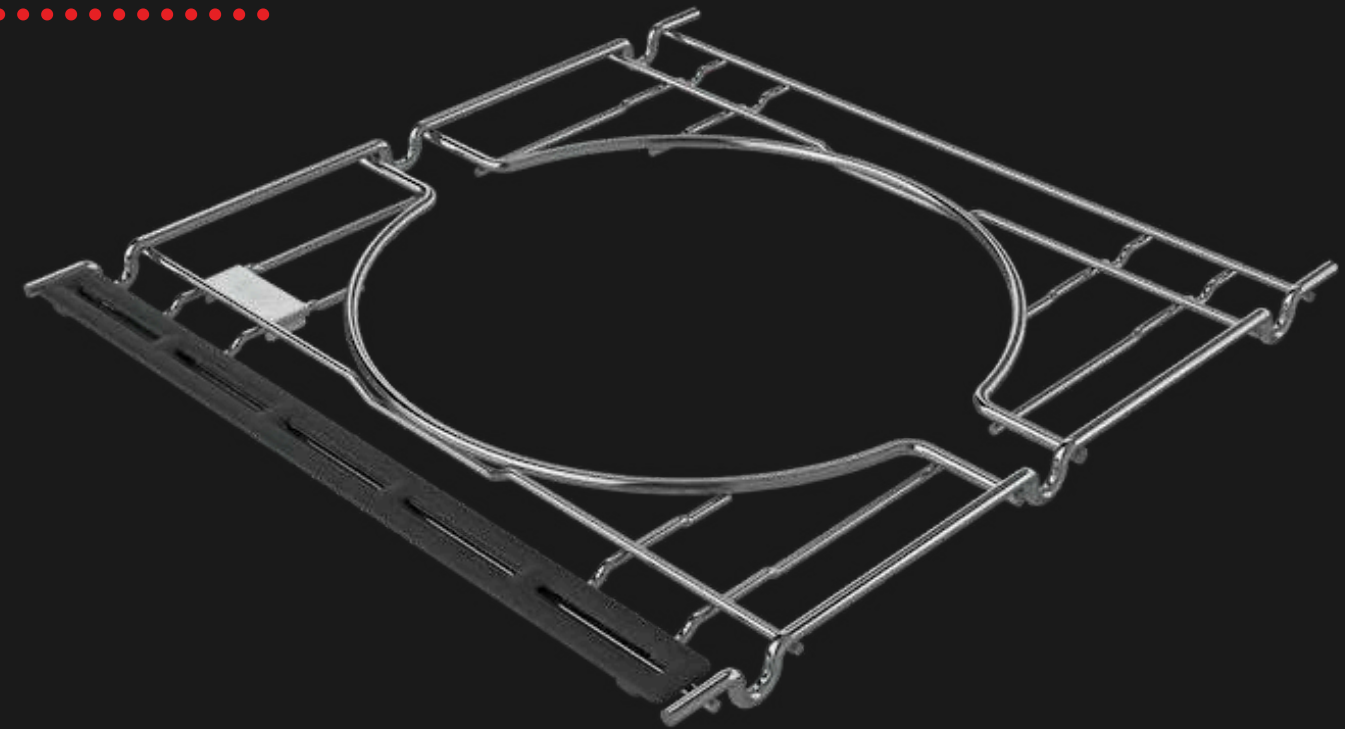

Simplemente reemplace su rejilla de cocción del lado derecho con el marco WEBER CRAFTED para desbloquear nuevas posibilidades de asar a la parrilla.

**WEBER CRAFTED FRAME KIT  
SPIRIT - SEARWOOD - SMOKEFIRE**

**Q600**

7678

**\*\*COMPATIBLE CON SPIRIT 2016+ GAS GRILLS, SEARWOOD 600/XL 600  
PELLET GRILLS, Y SMOKEFIRE EX4/EX6 WOOD PELLET GRILLS**



7757

## GENESIS COVER GRILL PREM

- \*VIENE CON EL ÍCONO BORDADO DE FÁBRICA
- \*COMPATIBLE CON GENESIS DE 3 QUEMADORES

Q1,000



7758

## **GENESIS COVER GRILL PREM**

- \*VIENE CON EL ÍCONO BORDADO DE FÁBRICA
- \*COMPATIBLE CON GENESIS DE 4 QUEMADORES

**Q1,100**



**Griddle Genesis II**  
4 quemadores  
**Q4,250.00**  
6789

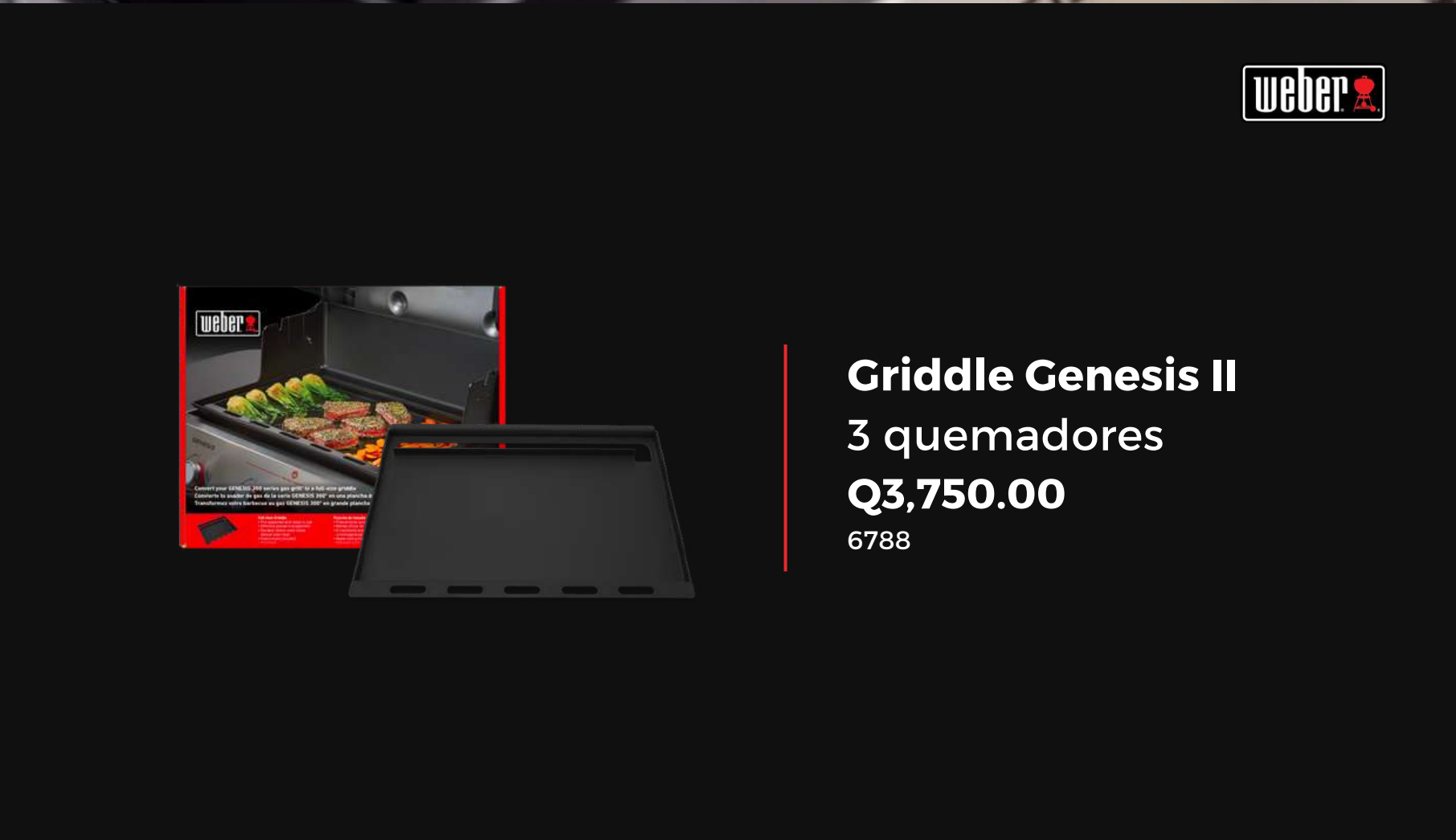

**Griddle Genesis II**  
3 quemadores  
**Q3,750.00**  
6788



6416

x10



**Large Drip Pans  
Q175**

Perfectos para ahumar  
o recibir grasa y jugos del corte



6498

x10



**Bandeja Larga  
Q150**

Perfecta para colocarle chips  
para ahumar o vegetales



6415

x10



**Bandeja pequeña  
Q125**

Para sistema de limpieza  
o asar vegetales

*jungla*



PLANCHAS



## COCINA SIN PUNTOS CALIENTES O FRÍOS

EL CALOR UNIFORME DE BORDE A BORDE TE PERMITE COCINAR ALIMENTOS DE MANERA CONSISTENTE, SIN PUNTOS FRÍOS O CALIENTES, SIN IMPORTAR DÓNDE LOS COLOQUES EN EL ÁREA DE COCCIÓN.



## LISTA PARA USAR NADA MÁS AL SACARLA DE LA CAJA

EL ÁREA DE COCCIÓN DE PORCELANA ESMALTADA RESISTENTE A LAS ADHERENCIAS FACILITA EL GIRAR Y DESLIZAR LOS ALIMENTOS POR LA PLANCHA MIENTRAS COCINAS.



## MANTÉN A LA MANO TUS ACCESORIOS PARA LA PLANCHA

EL SISTEMA DE PREPARACIÓN, COCCIÓN Y ALMACENAMIENTO WEBER WORKS FACILITA EL TRANSPORTE Y LA ORGANIZACIÓN DE TODO LO QUE NECESITAS, PARA QUE COCINAR A LA PLANCHA SEA MÁS CÓMODO Y DIVERTIDO.



# SLATE RUST-RESISTANT 30" Q10,400

1500014



Mueble abierto



Gas



# SLATE RUST-RESISTANT 30" CON TERMÓMETRO DIGITAL

## Q11,000

1500215



Termómetro digital

Espacio de almacenamiento



Gas



# SLATE RUST-RESISTANT 30" CON MESA EXTENDIBLE

## Q12,250

1500013



Termómetro digital

Cajones  
extraíbles

Mesa extendible



Gas



# SLATE RUST-RESISTANT 36"

CON MESA EXTENDIBLE Y 4 QUEMADORES

**Q15,500**

1500216



**NEW**



Termómetro digital

Espacio de almacenamiento

Mesa extendible



Gas



## PREMIUM GRIDDLE COVER

COMPATIBLE CON SLATE 30"

**SOLD OUT**

3400119



## PREMIUM GRIDDLE COVER

COMPATIBLE CON SLATE 36"

**SOLD OUT**

3400120





**TRAVELER PORTABLE  
GRIDDLE 17"**

**Q4,250**

1500012 / 1500531



**TRAVELER PORTABLE  
GRIDDLE 22"**

**Q5,600**

1500213 / 1500532

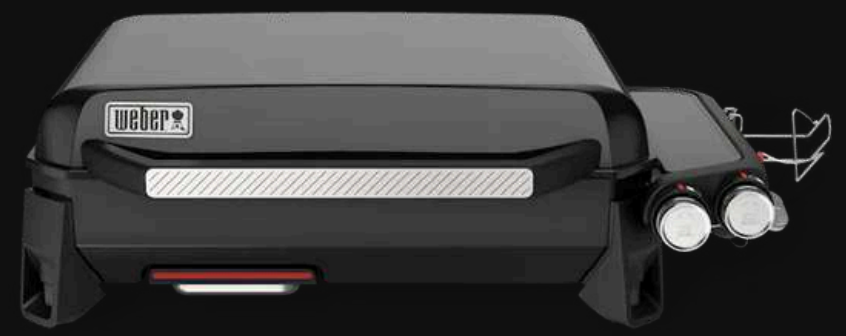

Gas



## EXPANDABLE STAND FOR TRAVELER PORTABLE GRIDDLE 17" & 22"

**SOLD OUT**

3400015





6778



BREAKFAST KIT GRIDDLE FT  
Q375



6780



SPATULA GRIDDLE FT FLEXIBLE  
Q250



6781



SCRAPER GRIDDLE FT  
Q200



6782



**SQUEEZE BOTTLES  
GRIDDLE FT  
Q150**



6783



**BASTING DOME GRIDDLE FT  
Q650**



6776



**TOOL SET GRIDDLE FT  
STARTER SET  
Q675**



3400074



PORTABLE GRIDDLE TOOL SET

SOLD OUT



9349



GRIDDLE SEASONING WAX

Q300



3400061



SMASHED BURGER SET

SOLD OUT



3400073

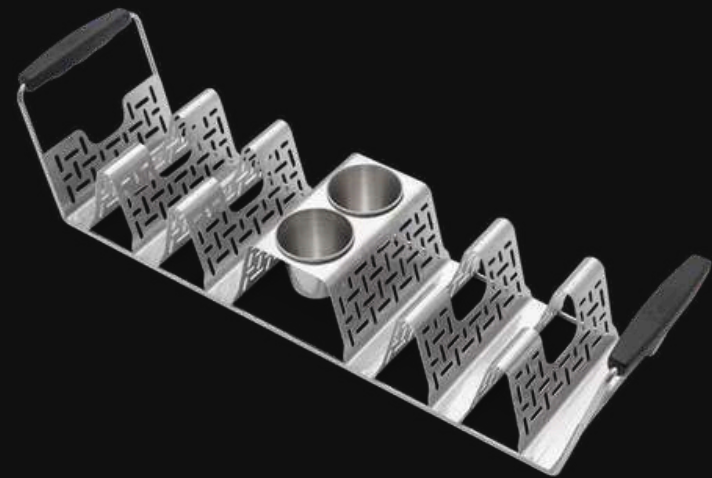

GRIDDLE TACO RACK

**SOLD OUT**



6777



GRIDDLE STARTER SET

**Q500**



6779



GRIDDLE SPATULA

**Q275**



3400105



WEBER WORKS - CONDIMENT CADDY

SOLD OUT



3400104



WEBER WORKS - BOTTLE HOLDER

Q150



3400106



WEBER WORKS - ORGANIZER KIT

Q600



3400131

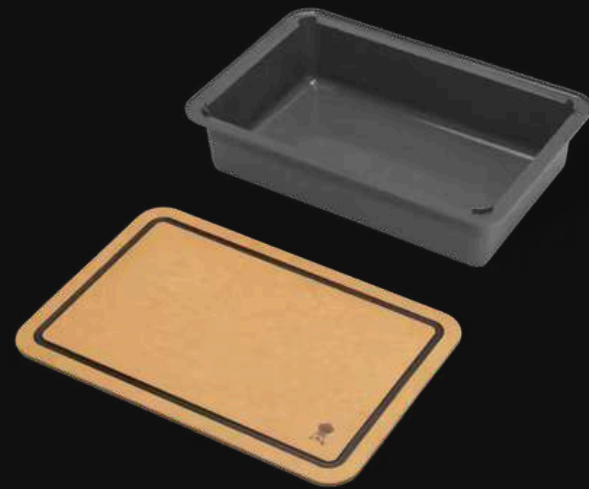

WEBER WORKS - BASIN WITH CUTTING BOARD

**Q475**



3400127

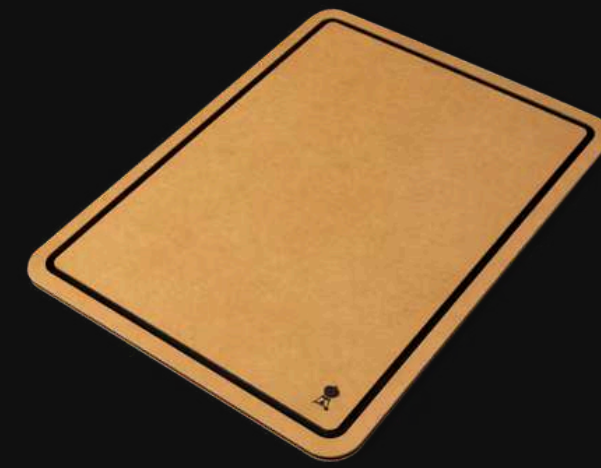

WEBER WORKS - CUTTING BOARD

**Q700**



6784



GRIDDLE KEEP WARM RACK

Q375



6785



GRIDDLE PRESS

SOLD OUT



6483



BURGER PRESS

Permite realizar tortas de 1/2 y 1/4 de lb.

Q200



3400024



**weber** | GRIDDLE CLEANING STONE

3 unidades

**Q175**



3400016



**weber** | TERMÓMETRO INFRAROJO

**Q750**



3400022

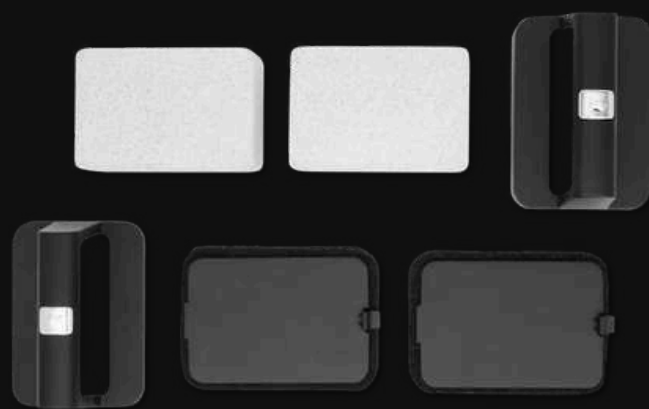

GRIDDLE CLEANING KIT 6PC

Q425

3400021



GRIDDLE CLEANING KIT 8PC

Q550

3400023



GRIDDLE SCOUR PAD  
REPLACEMENT 6PK

Q300

CHURRASQUERAS  
EMPOTRABLES

*jungla*



Gas

**Q20,000**

69008



**Steer | Gas Grill**

**24"**

CONFIRMAR  
STOCK

**Q35,000**

47628



**Angus | Gas Grill**

**30"**

CONFIRMAR  
STOCK

**Q45,000**

57568



**Brahma | Gas Grill**

**38"**

CONFIRMAR  
STOCK

PUEDES COMPRAR BAJO PEDIDO | PIDE EL CATÁLOGO DE EQUIPOS EMPOTRABLES

CONFIRMAR EXISTENCIAS . PRECIOS SUJETOS A CAMBIOS



Gas

**Q52,000**

62648



**Diablo | Gas Grill**

**46"**

CONTRA PEDIDO



CARBÓN

**Q25,000**

88787



**Bison | Carbón**

**30"**

CONFIRMAR STOCK

PUEDES COMPRAR BAJO PEDIDO | PIDE EL CATÁLOGO DE EQUIPOS EMPOTRABLES

CONFIRMAR EXISTENCIAS . PRECIOS SUJETOS A CAMBIOS



Gas

## **weber** | **SUMMIT SB38**

- 5 Quemadores Principales
- Perilla extra para sellar carne.
- Termómetro integrado a la tapa.
- Diseño con mueble abierto
- Acero Inoxidable
- Rosticero Eléctrico
- Luces automáticas
- Luces en perillas
- Caja de acero inoxidable para ahumar
- Grill para empotrar
- Mueble inferior adherido a la parrilla

CONSULTA POR MAYOR INFORMACIÓN  
**BAJO PEDIDO**



*jungla*



**weber** ACCESORIOS



7416



**Chimenea iniciadora  
de carbón compacta  
Q250**



**Chimenea iniciadora  
de carbón  
Q300**



7447



7649



**Charcoal Rake  
Q300**



17302



x2



**Tablas de cedro para  
ahumar  
Q100**



KJCHAR



LUMP CHARCOAL  
XL KAMADO

SOLO OUT



3400212



Briquetas - 20 lbs

SOLO OUT



7417



x24



Cubos de encendido  
Q75



7403



**CHAR-BASKETS**

**Q275**



7675

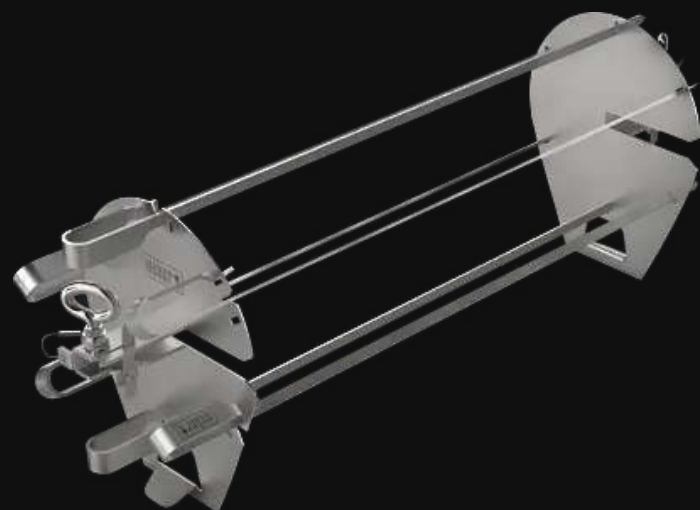

**Rotisserie Skewer Set**

**Q825**



7576

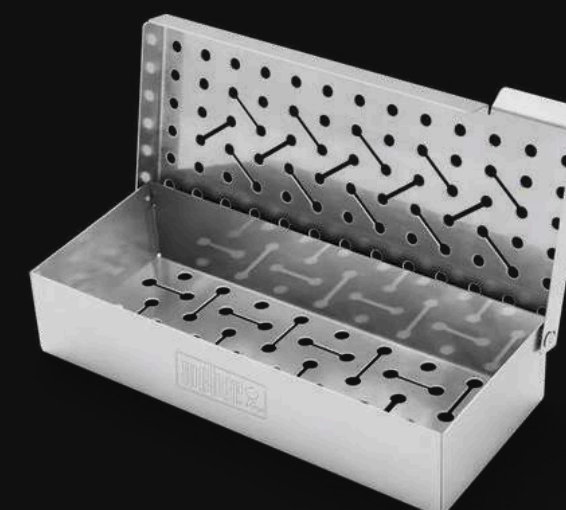

**Smoker Box**

**Q500**



7017



## SMOKING GLOVES

Q325

- Talla L de EE. UU., talla 9 de la UE
- Resistente al calor hasta 204 °C/400 °F



6532



## BBQ MITT Q150



6535



## Premium Gloves Q500

- Talla L de EE. UU., talla 9 de la UE
- Resistente al calor hasta 250 °C/482 °F



6768



**PRECISION TONGS**

**Q250**



6625



**PRECISION SET - TONGS & SPATULA**

**SOLD OUT**



6772



**PRECISION 3 PC GRILL TOOL SET**

**Q500**



6620



**STANDARD SPATULA**

**Q150**



6771



**PRECISION SET  
TONGS & SPATULA GRILLING**

**Q425**



6770



**SPATULA WIDE - PRECISION**

**Q300**



7008



45 mts

18"



**Butcher Paper  
Q600**



7032



13.5"

12"



**Cut & Catch Cutting Board  
Q400**



7005



17.6"

10.7"



**Cutting Board  
Q450**



6471

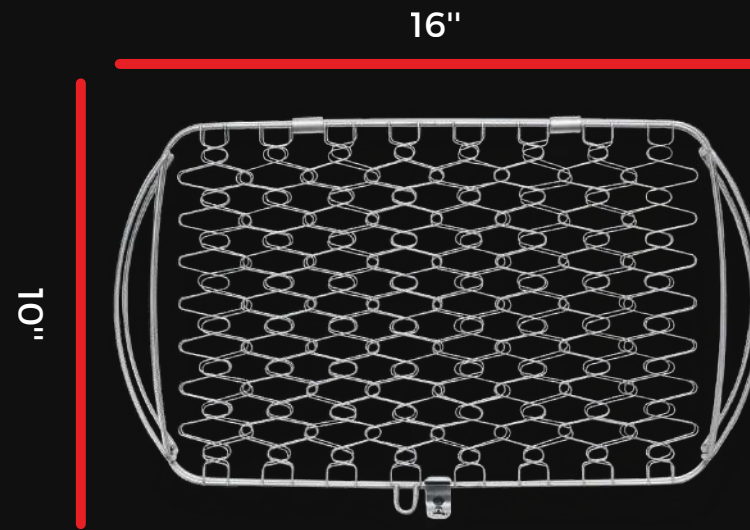

**Fish Basket - Large**

**SOLD OUT**



6470

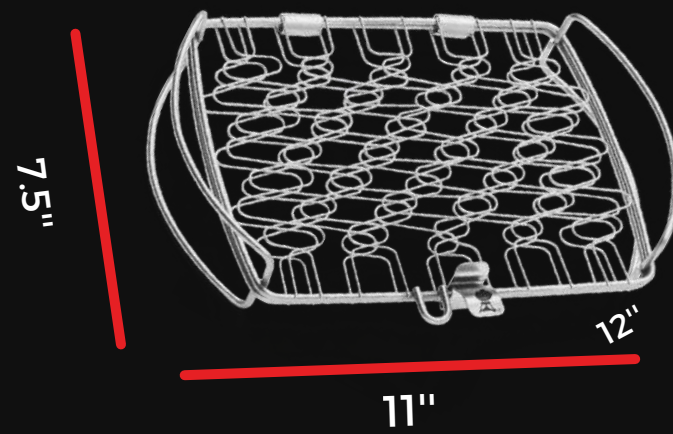

**Fish Basket - Small**

**SOLD OUT**



7647

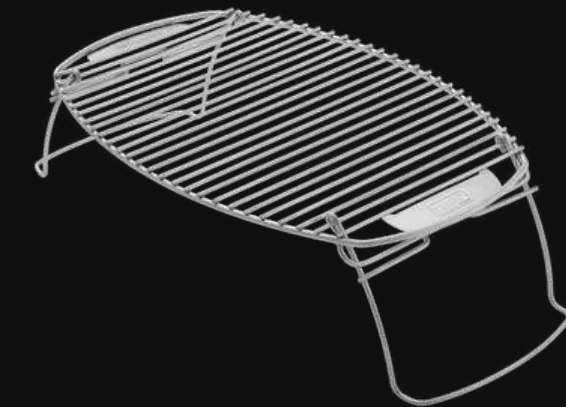

**Grilling Rack  
Q825**

6481



**Cesta Pequeña**  
**Q325**

6677



**Cesta Mediana**

SOLD OUT

6434



**Cesta grande**  
**Q425**

6482



**Soporte para pollo**  
**Q300**

6605



**Para medio costillar**  
**Q300**

6469



**Costillar grande**  
**para costillas y culotte**  
**Q425**



6691



**Paleta para pizza - Se dobla  
Q625**



6320



**Skewer Grilling Set  
Q150**



KJ-PP



**Paleta para pizza  
Q250**

\*EN INGLÉS

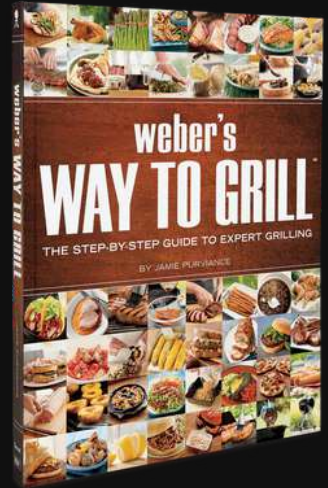

**Q300**  
9551

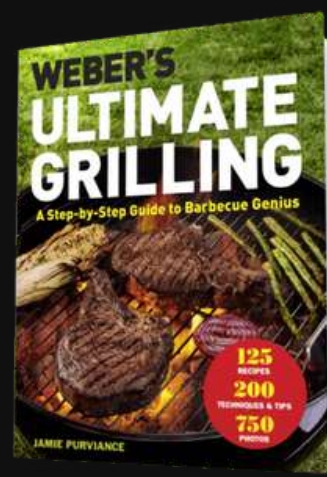

**SOLD OUT**  
9558

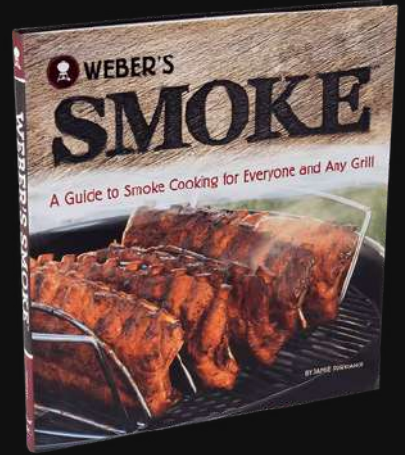

**Q300**  
7605

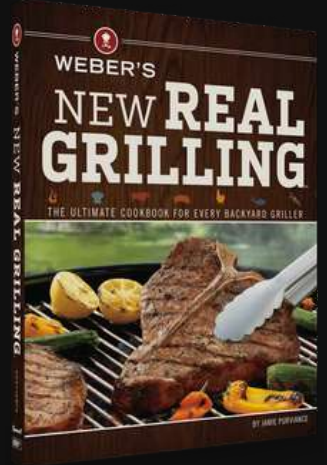

**Q300**  
9552

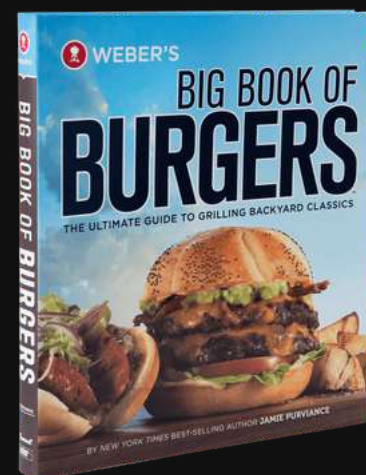

**SOLD OUT**  
9553

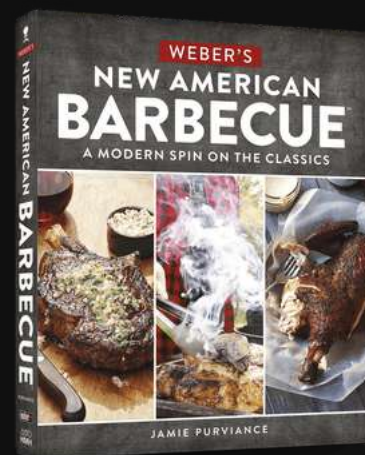

**SOLD OUT**  
9554

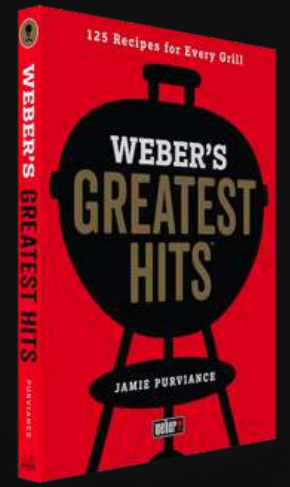

**Q300**  
9557



6277



12"



**Cleaning Brush  
Q175**



7401



**Grill & Tool Holder  
Q100**



6278



18"



**Cleaning Brush  
Q200**





Limpiador desengrasante  
en espuma



Limpieza interna  
**Q75**

101010320002



Pulidor exterior de acero  
en spray



Limpieza externa  
**Q100**

101010320001

8026

Fibra esponja de alto  
desempeño para parrillas



Limpieza interna  
**Q125**





6750



**Instant Read  
Q250**

7202



**iGrill Mini  
Q850**

7203



**iGrill 2  
Q1,500**

7204



**iGrill 3  
Q1,500**

Termómetro smart empotrable a  
SPIRIT II y GENESIS II.

7212 - Sonda de temperatura extra +Q275

3201



**Weber Connect**

**SOLD OUT**

Asistente inteligente  
paso a paso

7211 - Sonda de temperatura extra +Q275

**weber** | Bandeja para asar deluxe

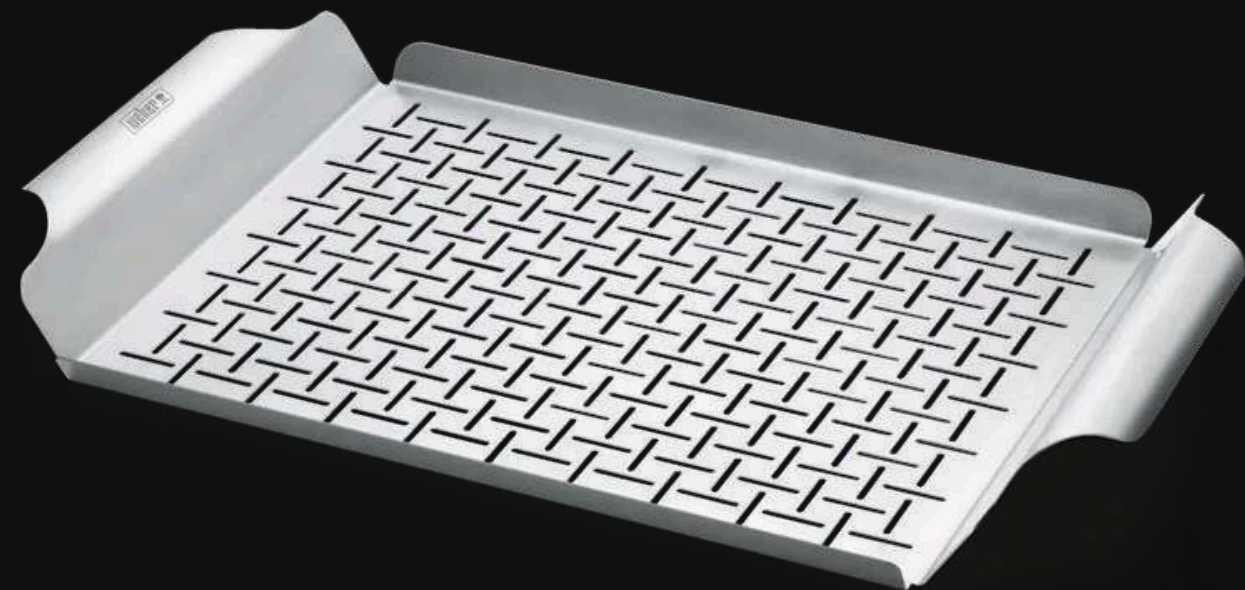

Saltea verduras mientras el filete adquiere color al lado. Usa la bandeja para asar Deluxe para aportar a cualquier plato ese inconfundible sabor a barbacoa.

**Q400**  
6435





**weber** | Grill & Griddle

**PARA GAS O CARBÓN**

Sella

Plancha



Para parillas de 3 quemadores en adelante o  
para churrasqueras de carbón de 22" en  
adelante

**Q1,200**  
8860



**weber** | Dutch Oven & Grill

**2 EN 1 - PLANCHA Y HIERRO**



La tapa puedes  
usarla como  
plancha

Hierro fundido porcenalizado con  
recubrimiento para facilitar limpieza

**Q2,100**  
8859

**weber** | Premium Grilling Stone

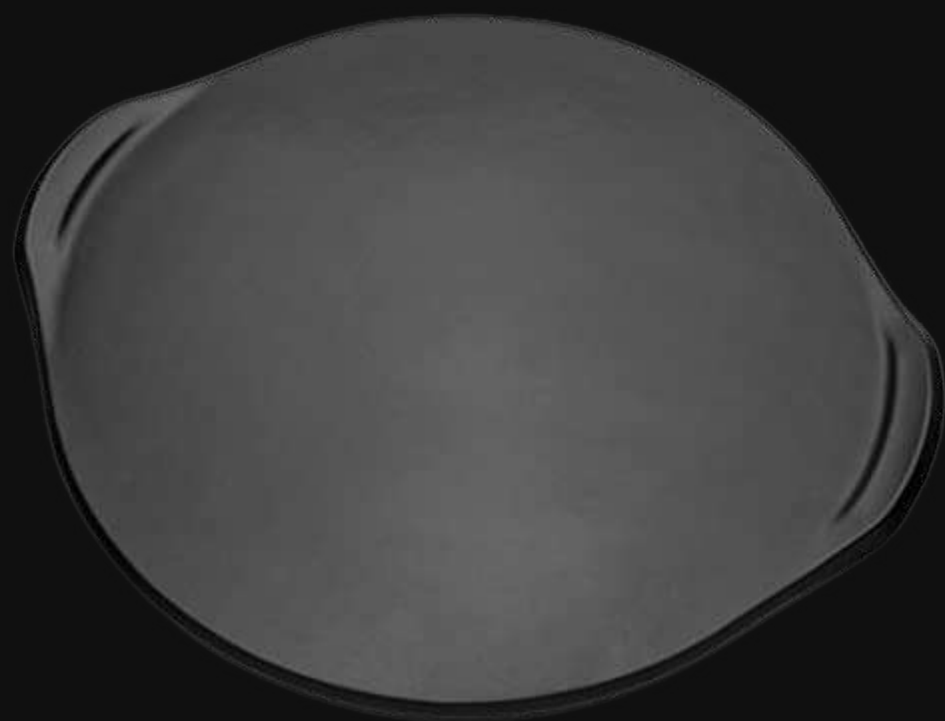

18.2" Diámetro - Hierro fundido porcelanizado

**SOLD OUT**

8829





## SOPORTE PARA POLLO CON INFUSOR DE LÍQUIDOS

Agrega cerveza,  
vino o líquido de tu  
preferencia para  
saborizar el pollo  
desde adentro



**Q600**  
6731



## Gabacha Weber Q250

\*viene con el ícono bordado de fábrica  
6534 / 6533



**GABACHA DE GABARDINA  
BORDADO DE NOMBRE**

**+ Q150**

DEMORA 3 DÍAS HÁBILES  
CONSULTA PRECIOS PARA LOGO



- 7 bolsillos para acceder fácilmente a los elementos esenciales de la churrasquera
- Material duradero y repelente de líquidos que protege la ropa
- El diseño de espalda cruzada brinda un ajuste cómodo
- Talla única con longitud y cintura ajustables
- Puede lavarse a lavadora



## | Gabacha Weber Q650

\*viene con el ícono bordado de fábrica  
6786

BORDADO DE NOMBRE  
+ Q150

DEMORA 3 DÍAS HÁBILES  
CONSULTA PRECIOS PARA LOGO